

Dante & Precision Time Protocol (PTP)

Technical Dive

Disclaimer

We are proud to join the technology community in evolving the language we use. Rethinking the words we use is just one of the ways to reduce barriers to equity and respect.

You may notice that throughout the presentation we will attempt as much as possible to use “Leader/Follower” instead of “Master/Slave”. There could be some places where we do not due to legacy content or applications that haven’t changed yet, but are in progress.

01 Let's Talk about Time

Comparison of Different Timing Sources

GPS (Global Position System)

- GPS with proper installation and calibration can provide 100ns accuracy
- Challenging installation process (access to open air) to lock with satellites
- It's costly and not straightforward to deploy in a large scale

IRIG (and other Serial Protocols)

- Mostly used in environments that require millisecond accuracy
- Faces the same challenges as GPS

NTP (Network Time Protocol)

- Traditionally NTP is used to provide timing information on packet networks
- Its accuracy is limited to millisecond level

PTP (Precision Timing Protocol)

- Defined in IEEE1588, distributed time synchronization protocol for packet network.
- Can provide nanosecond accuracy.

NTP & IEEE1588 Comparison

	NTP	IEEE 1588 PTP
Creation Date	1981	2002
Transport	Layer 3	Layer 2 & Layer 3
Scope	Internet	LAN
Mode of Operation	Client pulls time from Server	Leader pushes time to Follower
Frequency/Phase	Frequency & Phase	Frequency & Phase
Accuracy	Up to 1ms	Up to 100 ns (which is 0.0001 ms)
Timestamping	Software Timestamping*	Software or Hardware Timestamping
Hardware Dependency	No	Yes (higher accuracy and special hardware)
Cost	Cheaper	Comparatively more expensive

NTP & IEEE1588 Comparison: Distribution

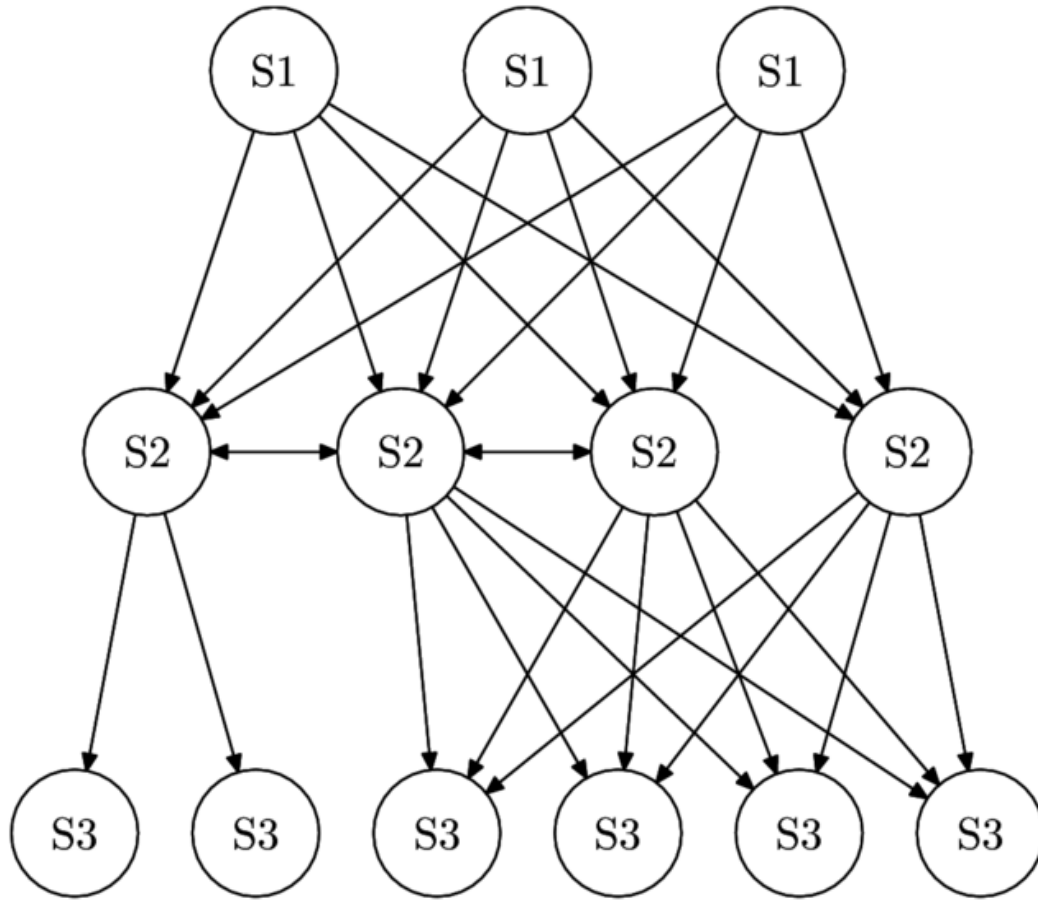

NTP strata

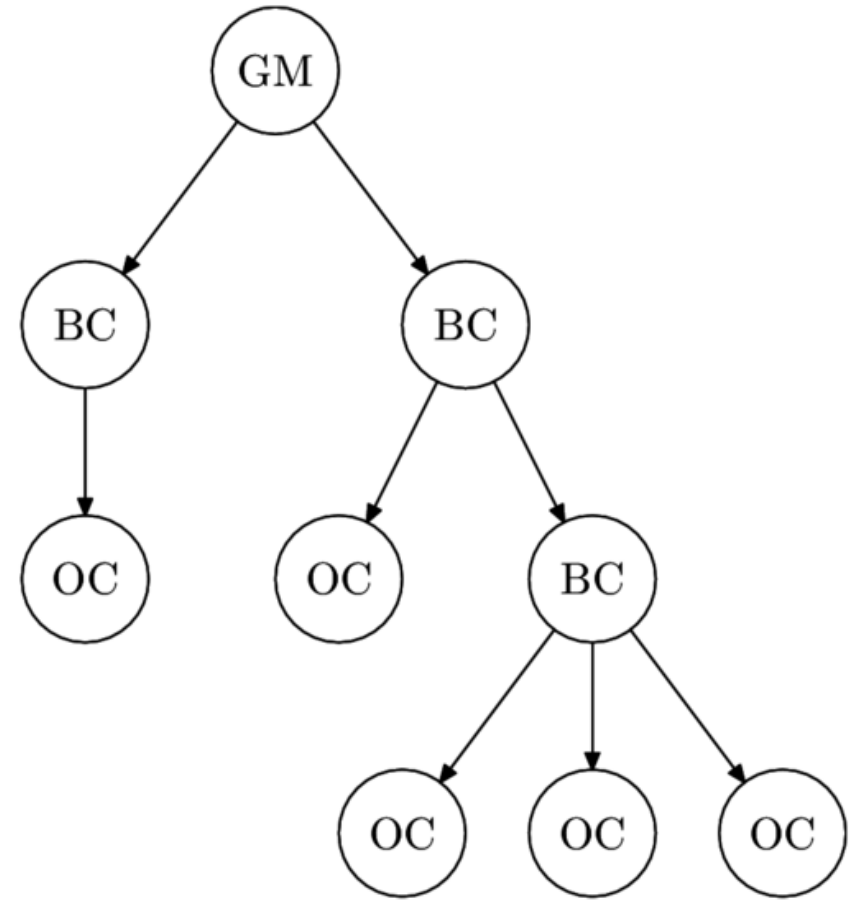

PTP domain

02 Precision Time Protocol (IEEE 1588)

Applications of Precision Time Protocol



Telecommunications
Mobile Backhaul



Financial Trading
High Frequency Trading



Audio Video Distribution
Multimedia Broadcast



Industrial Automation
Industrial Robots



Military Systems
Radar systems



Airline Industry
Air Traffic Control Systems



Smart Grid
Fault detection

IEEE 1588 Precision Time Protocol

The IEEE 1588 Standard, also known as Precision Time Protocol (PTP), is a **high-precision distributed time and frequency synchronization protocol** for IP networks, that is used for adjusting a devices' internal clock.

1. Client / Server Architecture (PTP Leader pushes time to PTP Followers)
2. Primarily uses Hardware Timestamping to provide better accuracy than NTP
3. Low administrative effort, easy to manage and maintain
4. Can be low cost, and has low resource use, works on high-end or low-end devices
5. Supports redundancy and has fault-tolerance
6. Message-based protocol, very limited bandwidth is required for PTP data packets

PTPv1 vs PTPv2

IEEE 1588-2002 is known as PTPv1

- It is a multicast only protocol

IEEE 1588-2008 is as known PTPv2

- IEEE 1588v2 is not backwards compatible with the IEEE 1588-2002 standard
 - But can coexist on a network with PTPv1
- Introduces features to PTPv1 that add flexibility, accuracy, and scalability like:
 - Can use unicast messaging and more flexible sync message rates.
 - Scalable on PTP aware networks where switches act as clocks (boundary or transparent) to reduce PTP traffic flooding.

IEEE 1588-2019 known as PTPv2.1

- Is backwards compatible and add some extra features

Timeline - Dante and PTP

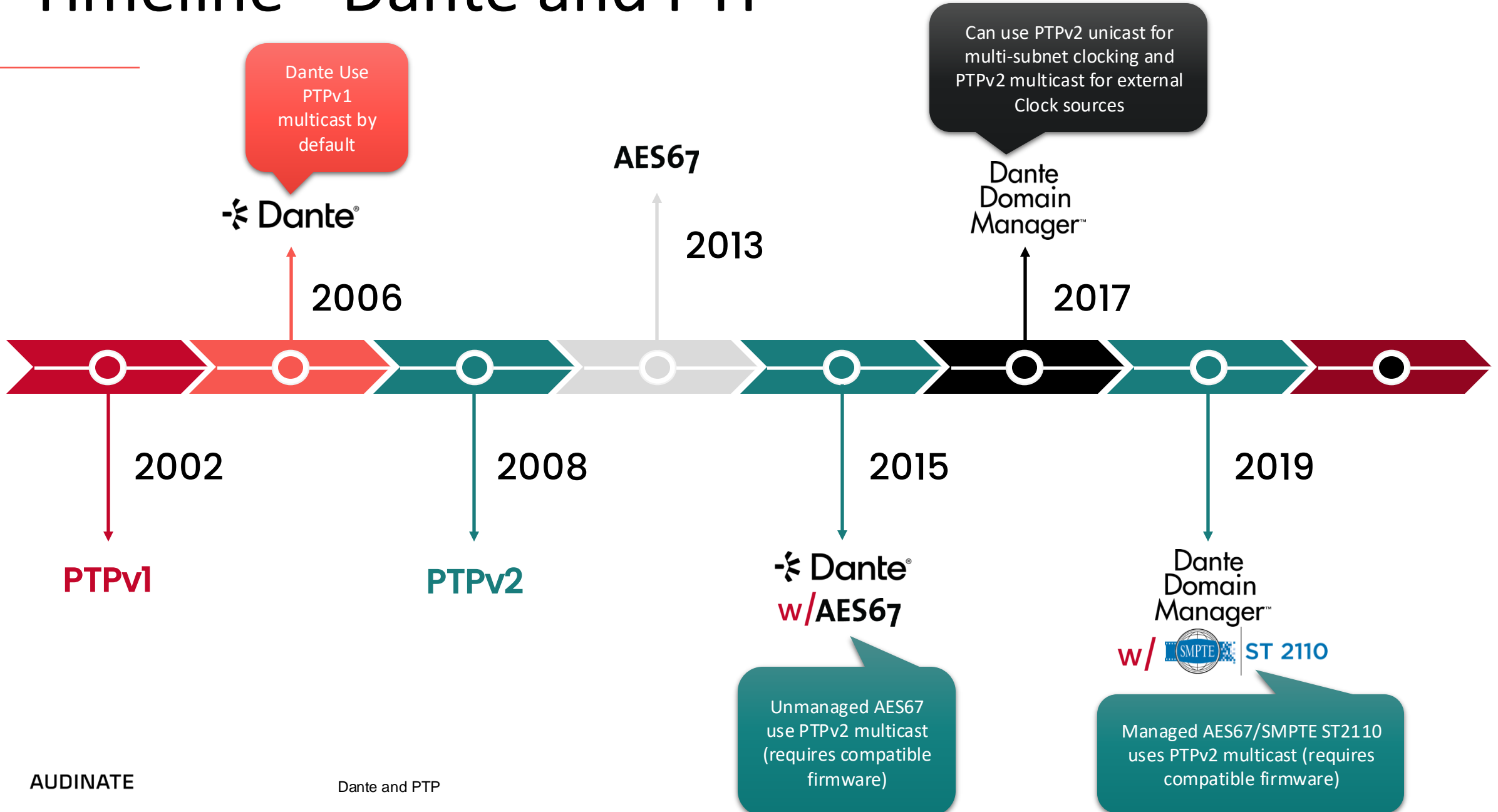

Others and PTP

PTPv2

Q-LAN™

Livewire

AES67

 | ST 2110

RAVENNA

IP MEDIA EXPERIENCE

gPTP

(simplified Layer 2 PTPv2 profile)

AVB

™

03 The math behind device synchronization

IEEE 1588 Message Types



Event Messages

Time Critical events used for Sync

Time stamped on egress from a node and ingress to a node

- Sync
- Delay_Request

General Messages

Not time stamped (but might contain timestamps for other messages)

- Follow-up
- Delay_Response
- Announce (v2)

What is Timestamping?

NTP or PTP calculations for clock synchronizations are based on timestamps.

Network timestamping is capturing or inserting the system time at which a packet entered (**ingress**) or left (**egress**) the network stack.

Timestamping accuracy will depend on the layer it was performed.

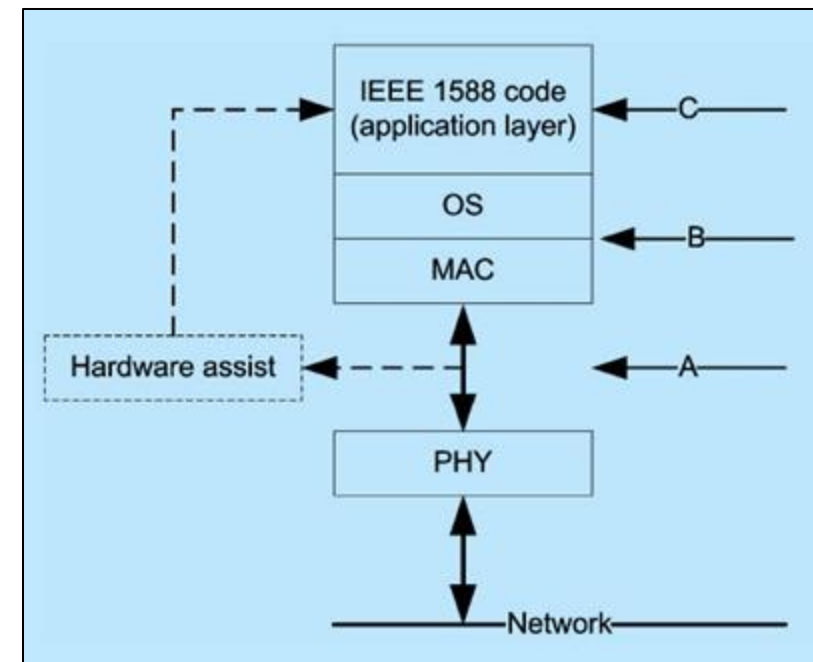

Timestamping: Software VS Hardware

Software Timestamping (NTP or PTP)

- Is done as a separate step to the packet sends/receives
- Can be affected by things like OS scheduling
- Can be performed at the
 - Application Layer (C) - 100 μ s to few ms
 - Operating System (B) - Tens of μ s

Hardware Timestamping

- Is much more precise but not all NICs support it
- Performed at the
 - Physical (MAC) layer (A) - nanoseconds range
- Enables packets to be timestamped the moment they come and go
- Requires application-specific integrated circuit (ASIC) for a switch

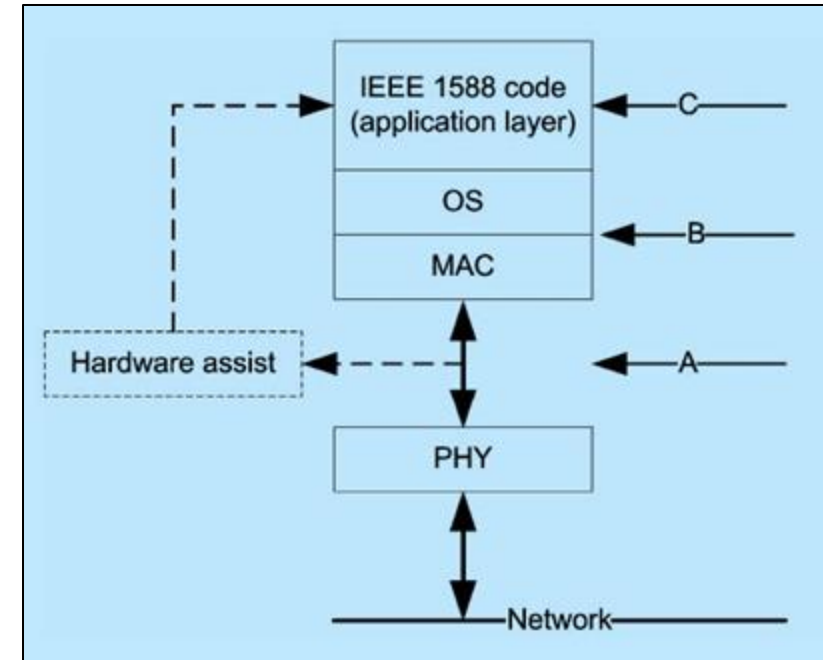

Clock Synchronization using PTP

Calculations are based on the PTP Messages Timestamps and assume that network paths are symmetrical.

Followers will:

1. Measure the delay between the leader clock and themselves (End to End E2E)
2. Adjust absolute time & speed using those measurements inside a PTP Control Loop

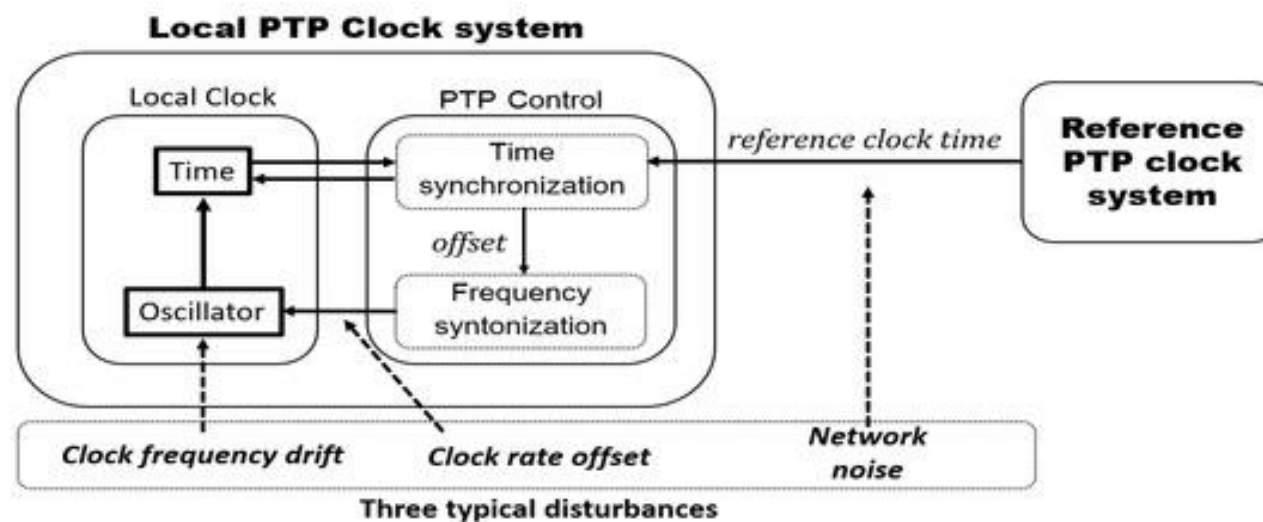

Clock Synchronization: Time & Speed Alignment

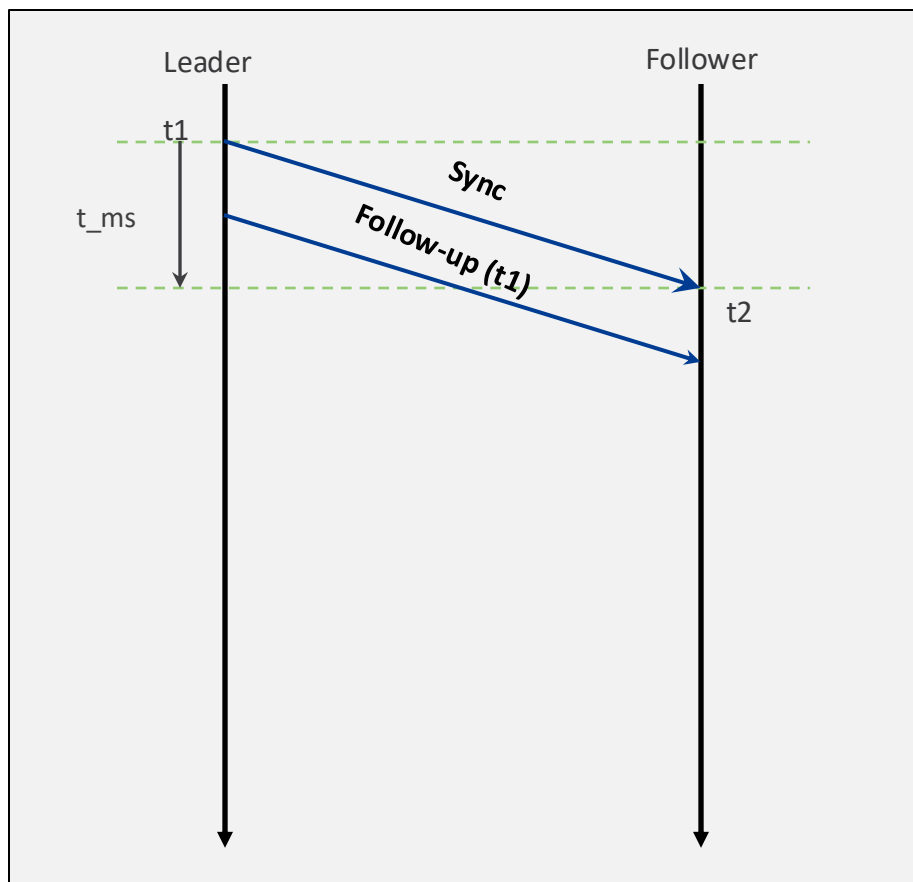

With Sync and Follow up messages we can align clock time and speed

1. Leader timestamps the egress *Sync* message (**t1**).
Not all devices can include the actual timestamp on the being sent packet.
 - One Step: hardware assistance allows **t1** to be included on the *Sync* packet.
 - Two Step: effective **t1** is included in the *Follow-up* message.
 - **Dante supports both One Step or Two Step in PTPv1/v2**
2. Follower timestamps the ingress *Sync* message (**t2**) and keeps the information.
3. Follower receives **t1** through the *Sync* or *Follow-up* message (One Step or Two Step)

Both Leader and Follower timestamp using their internal clocks.

Clock Synchronization: Phase Alignment

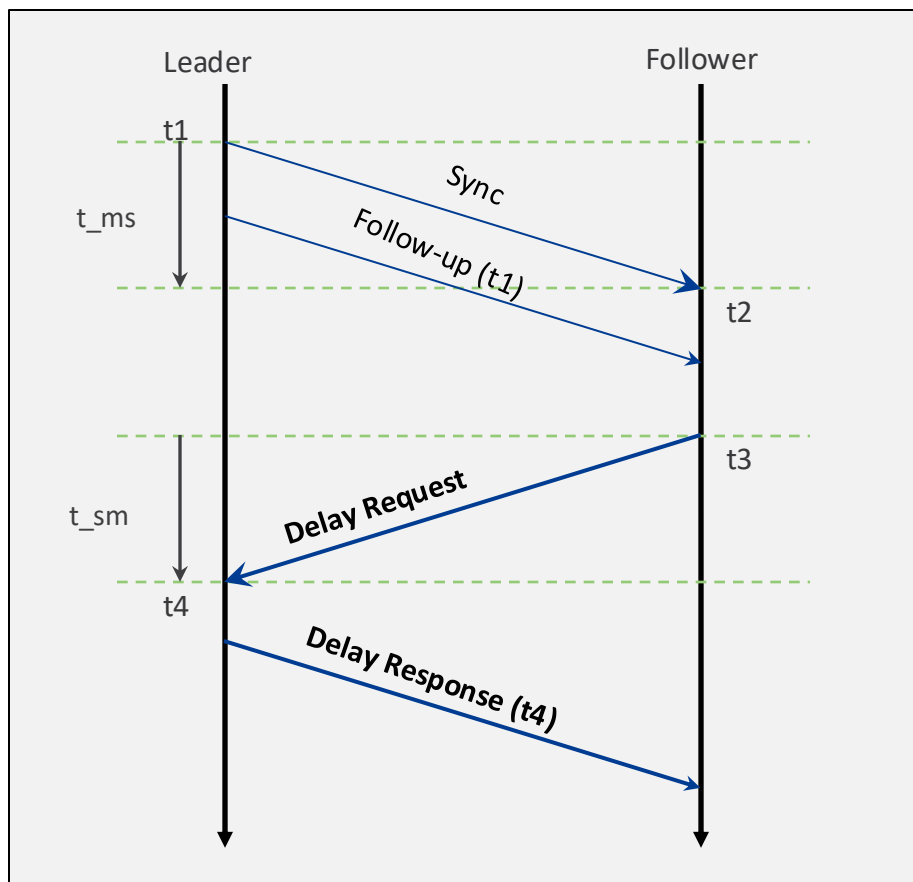

With Delay Request and Delay Response messages we can calculate the network propagation time (delay)

1. Follower timestamps the egress *Delay Request* message (**t3**) and keeps the information.
 - **t3** is not send on the *Delay Request* message
2. Leader timestamps ingress *Delay Request* message (**t4**)
3. Leader provides **t4** to the Follower over the *Delay Response* message

Both Leader and Follower timestamp using their internal clocks.

Clock Synchronization: Offset Alignment

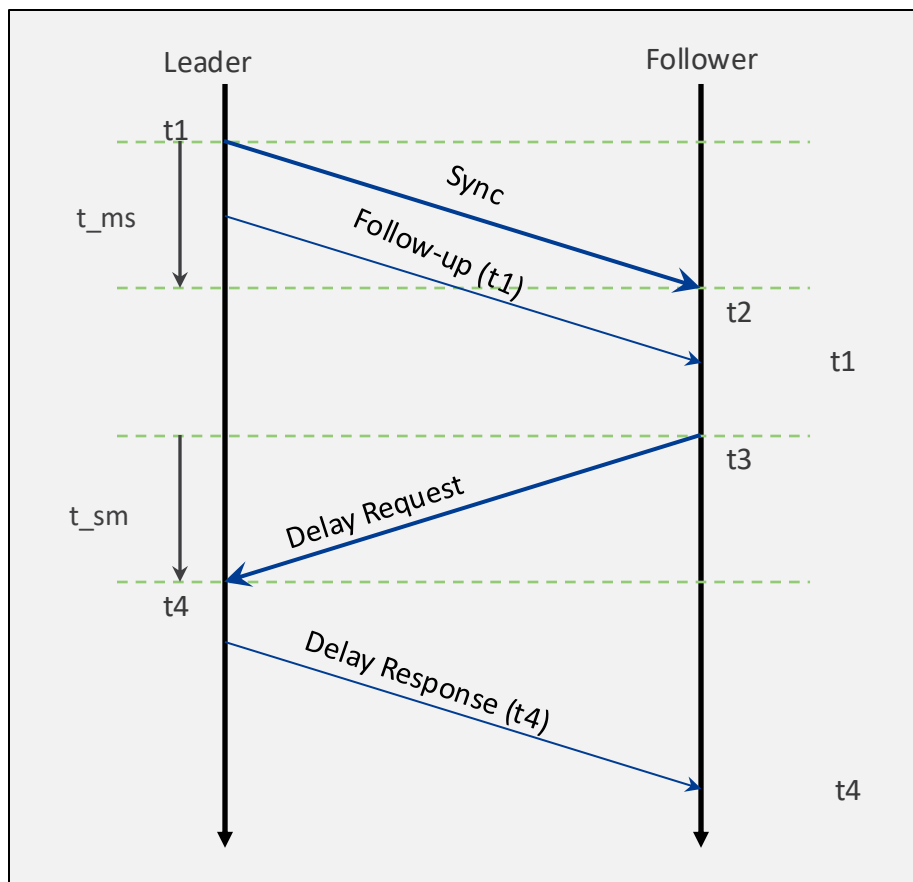

Both Leader and Follower timestamp using their internal clocks.

The math behind it

- The Follower now has all the timestamps (t_1 t_2 t_3 t_4) needed to calculate its offset with the Leader:
 - $\text{Delay} = [(t_2 - t_1) + (t_4 - t_3)] / 2$
 - $\text{Offset} = t_2 - t_1 - \text{Delay}$
 - $\text{Offset} = [(t_2 - t_1) - (t_4 - t_3)] / 2$**
- Follower feed its PTP Control Loop with the offset to adjust its internal Clock

Clock Sync in real life: PTPv1 sequence

Capturing from ThinkPad Lan: en8

dp.dstport == 319 || udp.dstport == 320

Packet No.	UTC Time	Time	Delta Time	DSCP v	Source Name	Source Port	Destination IP	Destination Name	Destination Port	Protocol	Length	Info
1549	22:15:04.038795	2024-03-18 23:15:04.038795	0.027739	CS7	Broadway-013c52. l...	50807	224.0.1.129	ptp-primary.mcas...	319	PTPv1	166	Sync Message
1550	22:15:04.039307	2024-03-18 23:15:04.039307	0.000512	EF PHB	Broadway-013c52. l...	50253	224.0.1.129	ptp-primary.mcas...	320	PTPv1	94	Follow_Up Message
1558	22:15:04.293487	2024-03-18 23:15:04.293487	0.068362	CS7	Broadway-013c52. l...	50807	224.0.1.129	ptp-primary.mcas...	319	PTPv1	166	Sync Message
1559	22:15:04.294014	2024-03-18 23:15:04.294014	0.000527	EF PHB	Broadway-013c52. l...	50253	224.0.1.129	ptp-primary.mcas...	320	PTPv1	94	Follow_Up Message
1567	22:15:04.557518	2024-03-18 23:15:04.557518	0.048240	CS7	Broadway-013c52. l...	50807	224.0.1.129	ptp-primary.mcas...	319	PTPv1	166	Sync Message
1568	22:15:04.558071	2024-03-18 23:15:04.558071	0.000553	EF PHB	Broadway-013c52. l...	50253	224.0.1.129	ptp-primary.mcas...	320	PTPv1	94	Follow_Up Message
1575	22:15:04.811855	2024-03-18 23:15:04.811855	0.002743	CS7	Broadway-013c52. l...	50807	224.0.1.129	ptp-primary.mcas...	319	PTPv1	166	Sync Message
1576	22:15:04.812409	2024-03-18 23:15:04.812409	0.000554	EF PHB	Broadway-013c52. l...	50253	224.0.1.129	ptp-primary.mcas...	320	PTPv1	94	Follow_Up Message
1586	22:15:05.066142	2024-03-18 23:15:05.066142	0.008369	CS7	Broadway-013c52. l...	50807	224.0.1.129	ptp-primary.mcas...	319	PTPv1	166	Sync Message
1587	22:15:05.066749	2024-03-18 23:15:05.066749	0.000607	EF PHB	Broadway-013c52. l...	50253	224.0.1.129	ptp-primary.mcas...	320	PTPv1	94	Follow_Up Message
1597	22:15:05.320868	2024-03-18 23:15:05.320868	0.011675	CS7	Broadway-013c52. l...	50807	224.0.1.129	ptp-primary.mcas...	319	PTPv1	166	Sync Message
1598	22:15:05.321377	2024-03-18 23:15:05.321377	0.000509	EF PHB	Broadway-013c52. l...	50253	224.0.1.129	ptp-primary.mcas...	320	PTPv1	94	Follow_Up Message
1612	22:15:05.584867	2024-03-18 23:15:05.584867	0.001514	CS7	Broadway-013c52. l...	50807	224.0.1.129	ptp-primary.mcas...	319	PTPv1	166	Sync Message
1613	22:15:05.585478	2024-03-18 23:15:05.585478	0.000611	EF PHB	Broadway-013c52. l...	50253	224.0.1.129	ptp-primary.mcas...	320	PTPv1	94	Follow_Up Message
1642	22:15:05.718677	2024-03-18 23:15:05.718677	0.009611	CS7	BKLYN-II-0bfd50. l...	50775	224.0.1.129	ptp-primary.mcas...	319	PTPv1	166	Delay_Request Message
1643	22:15:05.719382	2024-03-18 23:15:05.719382	0.000705	EF PHB	Broadway-013c52. l...	50253	224.0.1.129	ptp-primary.mcas...	320	PTPv1	102	Delay_Response Message
1648	22:15:05.839388	2024-03-18 23:15:05.839388	0.030295	CS7	Broadway-013c52. l...	50807	224.0.1.129	ptp-primary.mcas...	319	PTPv1	166	Sync Message
1649	22:15:05.839865	2024-03-18 23:15:05.839865	0.000477	EF PHB	Broadway-013c52. l...	50253	224.0.1.129	ptp-primary.mcas...	320	PTPv1	94	Follow_Up Message
1660	22:15:06.094046	2024-03-18 23:15:06.094046	0.038273	CS7	Broadway-013c52. l...	50807	224.0.1.129	ptp-primary.mcas...	319	PTPv1	166	Sync Message
1661	22:15:06.094517	2024-03-18 23:15:06.094517	0.000471	EF PHB	Broadway-013c52. l...	50253	224.0.1.129	ptp-primary.mcas...	320	PTPv1	94	Follow_Up Message
1682	22:15:06.358149	2024-03-18 23:15:06.358149	0.002320	CS7	Broadway-013c52. l...	50807	224.0.1.129	ptp-primary.mcas...	319	PTPv1	166	Sync Message
1683	22:15:06.358634	2024-03-18 23:15:06.358634	0.000485	EF PHB	Broadway-013c52. l...	50253	224.0.1.129	ptp-primary.mcas...	320	PTPv1	94	Follow_Up Message
1691	22:15:06.612347	2024-03-18 23:15:06.612347	0.003193	CS7	Broadway-013c52. l...	50807	224.0.1.129	ptp-primary.mcas...	319	PTPv1	166	Sync Message
1692	22:15:06.612877	2024-03-18 23:15:06.612877	0.000530	EF PHB	Broadway-013c52. l...	50253	224.0.1.129	ptp-primary.mcas...	320	PTPv1	94	Follow_Up Message
1709	22:15:06.867113	2024-03-18 23:15:06.867113	0.058076	CS7	Broadway-013c52. l...	50807	224.0.1.129	ptp-primary.mcas...	319	PTPv1	166	Sync Message
1710	22:15:06.867555	2024-03-18 23:15:06.867555	0.000442	EF PHB	Broadway-013c52. l...	50253	224.0.1.129	ptp-primary.mcas...	320	PTPv1	94	Follow_Up Message
1725	22:15:07.131239	2024-03-18 23:15:07.131239	0.022179	CS7	Broadway-013c52. l...	50807	224.0.1.129	ptp-primary.mcas...	319	PTPv1	166	Sync Message
1726	22:15:07.131837	2024-03-18 23:15:07.131837	0.000598	EF PHB	Broadway-013c52. l...	50253	224.0.1.129	ptp-primary.mcas...	320	PTPv1	94	Follow_Up Message
1734	22:15:07.385920	2024-03-18 23:15:07.385920	0.076820	CS7	Broadway-013c52. l...	50807	224.0.1.129	ptp-primary.mcas...	319	PTPv1	166	Sync Message
1735	22:15:07.386386	2024-03-18 23:15:07.386386	0.000466	EF PHB	Broadway-013c52. l...	50253	224.0.1.129	ptp-primary.mcas...	320	PTPv1	94	Follow_Up Message
1741	22:15:07.570140	2024-03-18 23:15:07.570140	0.035612	CS7	BKLYN-II-0bfd50. l...	50775	224.0.1.129	ptp-primary.mcas...	319	PTPv1	166	Delay_Request Message
1742	22:15:07.570802	2024-03-18 23:15:07.570802	0.000662	EF PHB	Broadway-013c52. l...	50253	224.0.1.129	ptp-primary.mcas...	320	PTPv1	102	Delay_Response Message
1745	22:15:07.650023	2024-03-18 23:15:07.650023	0.041040	CS7	Broadway-013c52. l...	50807	224.0.1.129	ptp-primary.mcas...	319	PTPv1	166	Sync Message
1746	22:15:07.650480	2024-03-18 23:15:07.650480	0.000457	EF PHB	Broadway-013c52. l...	50253	224.0.1.129	ptp-primary.mcas...	320	PTPv1	94	Follow_Up Message
1751	22:15:07.904353	2024-03-18 23:15:07.904353	0.095312	CS7	Broadway-013c52. l...	50807	224.0.1.129	ptp-primary.mcas...	319	PTPv1	166	Sync Message
1752	22:15:07.904784	2024-03-18 23:15:07.904784	0.000431	EF PHB	Broadway-013c52. l...	50253	224.0.1.129	ptp-primary.mcas...	320	PTPv1	94	Follow_Up Message
1763	22:15:08.158666	2024-03-18 23:15:08.158666	0.049547	CS7	Broadway-013c52. l...	50807	224.0.1.129	ptp-primary.mcas...	319	PTPv1	166	Sync Message
1764	22:15:08.159121	2024-03-18 23:15:08.159121	0.000455	EF PHB	Broadway-013c52. l...	50253	224.0.1.129	ptp-primary.mcas...	320	PTPv1	94	Follow_Up Message
1774	22:15:08.412922	2024-03-18 23:15:08.412922	0.003678	CS7	Broadway-013c52. l...	50807	224.0.1.129	ptp-primary.mcas...	319	PTPv1	166	Sync Message
1775	22:15:08.413464	2024-03-18 23:15:08.413464	0.000542	EF PHB	Broadway-013c52. l...	50253	224.0.1.129	ptp-primary.mcas...	320	PTPv1	94	Follow_Up Message
1781	22:15:08.667698	2024-03-18 23:15:08.667698	0.058505	CS7	Broadway-013c52. l...	50807	224.0.1.129	ptp-primary.mcas...	319	PTPv1	166	Sync Message
1782	22:15:08.668239	2024-03-18 23:15:08.668239	0.000541	EF PHB	Broadway-013c52. l...	50253	224.0.1.129	ptp-primary.mcas...	320	PTPv1	94	Follow_Up Message
1791	22:15:08.931794	2024-03-18 23:15:08.931794	0.022434	CS7	Broadway-013c52. l...	50807	224.0.1.129	ptp-primary.mcas...	319	PTPv1	166	Sync Message
1792	22:15:08.932248	2024-03-18 23:15:08.932248	0.000454	EF PHB	Broadway-013c52. l...	50253	224.0.1.129	ptp-primary.mcas...	320	PTPv1	94	Follow_Up Message
1804	22:15:09.186514	2024-03-18 23:15:09.186514	0.077235	CS7	Broadway-013c52. l...	50807	224.0.1.129	ptp-primary.mcas...	319	PTPv1	166	Sync Message
1805	22:15:09.186908	2024-03-18 23:15:09.186908	0.000394	EF PHB	Broadway-013c52. l...	50253	224.0.1.129	ptp-primary.mcas...	320	PTPv1	94	Follow_Up Message
1817	22:15:09.450675	2024-03-18 23:15:09.450675	0.041461	CS7	Broadway-013c52. l...	50807	224.0.1.129	ptp-primary.mcas...	319	PTPv1	166	Sync Message

Clock Sync in real life: PTPv2 sequence

Capturing from ThinkPad Lan: en8

dp.dstport == 319 || udp.dstport == 320

Packet No.	UTC Time	Time	Delta Time	DSCP v	Source Name	Source Port	Destination IP	Destination Name	Destination I	Protoco	Length	Info
83542	22:32:40.737007	2024-03-18 23:32:40.737007	0.090882	EF PHB	Broadway-013c52. L...	51281	224.0.1.129	ptp-primary.mcas...	320	PTPv2	106	Announce Message
83545	22:32:40.900315	2024-03-18 23:32:40.900315	0.060688	EF PHB	Broadway-013c52. L...	52858	224.0.1.129	ptp-primary.mcas...	319	PTPv2	86	Sync Message
83546	22:32:40.900721	2024-03-18 23:32:40.900721	0.000406	EF PHB	Broadway-013c52. L...	51281	224.0.1.129	ptp-primary.mcas...	320	PTPv2	86	Follow_Up Message
83554	22:32:41.100583	2024-03-18 23:32:41.100583	0.040456	EF PHB	BKLYN-II-0bfd50. L...	49914	224.0.1.129	ptp-primary.mcas...	319	PTPv2	86	Delay_Req Message
83555	22:32:41.100890	2024-03-18 23:32:41.100890	0.000307	EF PHB	Broadway-013c52. L...	51281	224.0.1.129	ptp-primary.mcas...	320	PTPv2	96	Delay_Resp Message
83569	22:32:41.165133	2024-03-18 23:32:41.165133	0.007494	EF PHB	Broadway-013c52. L...	52858	224.0.1.129	ptp-primary.mcas...	319	PTPv2	86	Sync Message
83570	22:32:41.165337	2024-03-18 23:32:41.165337	0.000204	EF PHB	Broadway-013c52. L...	51281	224.0.1.129	ptp-primary.mcas...	320	PTPv2	86	Follow_Up Message
83575	22:32:41.418864	2024-03-18 23:32:41.418864	0.079355	EF PHB	Broadway-013c52. L...	52858	224.0.1.129	ptp-primary.mcas...	319	PTPv2	86	Sync Message
83576	22:32:41.419262	2024-03-18 23:32:41.419262	0.000398	EF PHB	Broadway-013c52. L...	51281	224.0.1.129	ptp-primary.mcas...	320	PTPv2	86	Follow_Up Message
83581	22:32:41.673013	2024-03-18 23:32:41.673013	0.033465	EF PHB	Broadway-013c52. L...	52858	224.0.1.129	ptp-primary.mcas...	319	PTPv2	86	Sync Message
83582	22:32:41.673584	2024-03-18 23:32:41.673584	0.000571	EF PHB	Broadway-013c52. L...	51281	224.0.1.129	ptp-primary.mcas...	320	PTPv2	86	Follow_Up Message
83584	22:32:41.754316	2024-03-18 23:32:41.754316	0.014785	EF PHB	Broadway-013c52. L...	51281	224.0.1.129	ptp-primary.mcas...	320	PTPv2	106	Announce Message
83586	22:32:41.927638	2024-03-18 23:32:41.927638	0.088102	EF PHB	Broadway-013c52. L...	52858	224.0.1.129	ptp-primary.mcas...	319	PTPv2	86	Sync Message
83587	22:32:41.928182	2024-03-18 23:32:41.928182	0.000544	EF PHB	Broadway-013c52. L...	51281	224.0.1.129	ptp-primary.mcas...	320	PTPv2	86	Follow_Up Message
83596	22:32:42.191858	2024-03-18 23:32:42.191858	0.051050	EF PHB	Broadway-013c52. L...	52858	224.0.1.129	ptp-primary.mcas...	319	PTPv2	86	Sync Message
83597	22:32:42.192338	2024-03-18 23:32:42.192338	0.000480	EF PHB	Broadway-013c52. L...	51281	224.0.1.129	ptp-primary.mcas...	320	PTPv2	86	Follow_Up Message
83599	22:32:42.224148	2024-03-18 23:32:42.224148	0.000876	EF PHB	BKLYN-II-0bfd50. L...	49914	224.0.1.129	ptp-primary.mcas...	319	PTPv2	86	Delay_Req Message
83600	22:32:42.224838	2024-03-18 23:32:42.224838	0.000690	EF PHB	Broadway-013c52. L...	51281	224.0.1.129	ptp-primary.mcas...	320	PTPv2	96	Delay_Resp Message
83611	22:32:42.446156	2024-03-18 23:32:42.446156	0.003785	EF PHB	Broadway-013c52. L...	52858	224.0.1.129	ptp-primary.mcas...	319	PTPv2	86	Sync Message
83612	22:32:42.446614	2024-03-18 23:32:42.446614	0.000458	EF PHB	Broadway-013c52. L...	51281	224.0.1.129	ptp-primary.mcas...	320	PTPv2	86	Follow_Up Message
83618	22:32:42.700707	2024-03-18 23:32:42.700707	0.061136	EF PHB	Broadway-013c52. L...	52858	224.0.1.129	ptp-primary.mcas...	319	PTPv2	86	Sync Message
83619	22:32:42.701260	2024-03-18 23:32:42.701260	0.000553	EF PHB	Broadway-013c52. L...	51281	224.0.1.129	ptp-primary.mcas...	320	PTPv2	86	Follow_Up Message
83622	22:32:42.771891	2024-03-18 23:32:42.771891	0.032356	EF PHB	Broadway-013c52. L...	51281	224.0.1.129	ptp-primary.mcas...	320	PTPv2	106	Announce Message
83629	22:32:42.964836	2024-03-18 23:32:42.964836	0.025314	EF PHB	Broadway-013c52. L...	52858	224.0.1.129	ptp-primary.mcas...	319	PTPv2	86	Sync Message
83630	22:32:42.965445	2024-03-18 23:32:42.965445	0.000609	EF PHB	Broadway-013c52. L...	51281	224.0.1.129	ptp-primary.mcas...	320	PTPv2	86	Follow_Up Message
83639	22:32:43.219128	2024-03-18 23:32:43.219128	0.044308	EF PHB	Broadway-013c52. L...	52858	224.0.1.129	ptp-primary.mcas...	319	PTPv2	86	Sync Message
83640	22:32:43.219705	2024-03-18 23:32:43.219705	0.000577	EF PHB	Broadway-013c52. L...	51281	224.0.1.129	ptp-primary.mcas...	320	PTPv2	86	Follow_Up Message
83654	22:32:43.473971	2024-03-18 23:32:43.473971	0.034436	EF PHB	Broadway-013c52. L...	52858	224.0.1.129	ptp-primary.mcas...	319	PTPv2	86	Sync Message
83655	22:32:43.474352	2024-03-18 23:32:43.474352	0.000381	EF PHB	Broadway-013c52. L...	51281	224.0.1.129	ptp-primary.mcas...	320	PTPv2	86	Follow_Up Message
83656	22:32:43.488008	2024-03-18 23:32:43.488008	0.013656	EF PHB	BKLYN-II-0bfd50. L...	49914	224.0.1.129	ptp-primary.mcas...	319	PTPv2	86	Delay_Req Message
83657	22:32:43.488543	2024-03-18 23:32:43.488543	0.000535	EF PHB	Broadway-013c52. L...	51281	224.0.1.129	ptp-primary.mcas...	320	PTPv2	96	Delay_Resp Message
83663	22:32:43.737934	2024-03-18 23:32:43.737934	0.085139	EF PHB	Broadway-013c52. L...	52858	224.0.1.129	ptp-primary.mcas...	319	PTPv2	86	Sync Message
83664	22:32:43.738535	2024-03-18 23:32:43.738535	0.000601	EF PHB	Broadway-013c52. L...	51281	224.0.1.129	ptp-primary.mcas...	320	PTPv2	86	Follow_Up Message
83667	22:32:43.798978	2024-03-18 23:32:43.798978	0.058092	EF PHB	Broadway-013c52. L...	51281	224.0.1.129	ptp-primary.mcas...	320	PTPv2	106	Announce Message
83672	22:32:43.992296	2024-03-18 23:32:43.992296	0.052807	EF PHB	Broadway-013c52. L...	52858	224.0.1.129	ptp-primary.mcas...	319	PTPv2	86	Sync Message
83673	22:32:43.992831	2024-03-18 23:32:43.992831	0.000535	EF PHB	Broadway-013c52. L...	51281	224.0.1.129	ptp-primary.mcas...	320	PTPv2	86	Follow_Up Message
83685	22:32:44.246696	2024-03-18 23:32:44.246696	0.007175	EF PHB	Broadway-013c52. L...	52858	224.0.1.129	ptp-primary.mcas...	319	PTPv2	86	Sync Message
83686	22:32:44.247142	2024-03-18 23:32:44.247142	0.000446	EF PHB	Broadway-013c52. L...	51281	224.0.1.129	ptp-primary.mcas...	320	PTPv2	86	Follow_Up Message
83689	22:32:44.322202	2024-03-18 23:32:44.322202	0.011763	EF PHB	BKLYN-II-0bfd50. L...	49914	224.0.1.129	ptp-primary.mcas...	319	PTPv2	86	Delay_Req Message
83690	22:32:44.322780	2024-03-18 23:32:44.322780	0.000578	EF PHB	Broadway-013c52. L...	51281	224.0.1.129	ptp-primary.mcas...	320	PTPv2	96	Delay_Resp Message
83697	22:32:44.501270	2024-03-18 23:32:44.501270	0.061475	EF PHB	Broadway-013c52. L...	52858	224.0.1.129	ptp-primary.mcas...	319	PTPv2	86	Sync Message
83698	22:32:44.501805	2024-03-18 23:32:44.501805	0.000535	EF PHB	Broadway-013c52. L...	51281	224.0.1.129	ptp-primary.mcas...	320	PTPv2	86	Follow_Up Message
83706	22:32:44.765341	2024-03-18 23:32:44.765341	0.025787	EF PHB	Broadway-013c52. L...	52858	224.0.1.129	ptp-primary.mcas...	319	PTPv2	86	Sync Message

Clock Sync in real life: PTPv2 packets detail

Announce

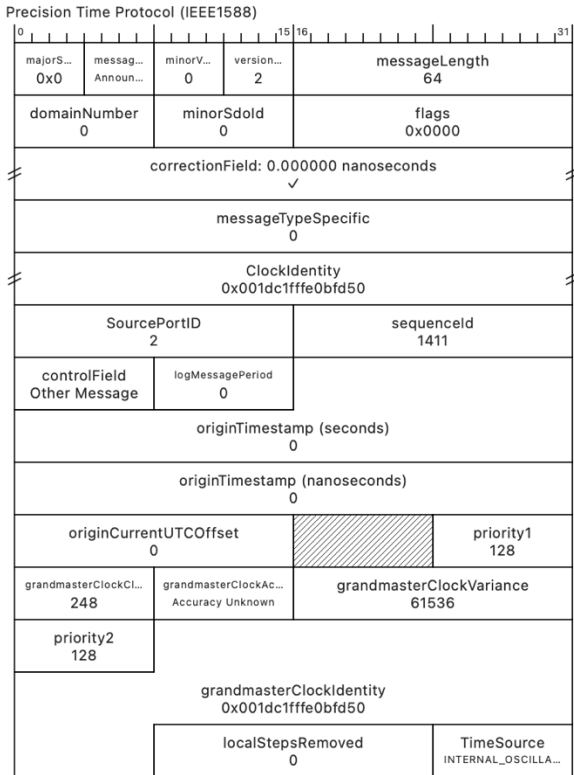

Sync

Follow-up

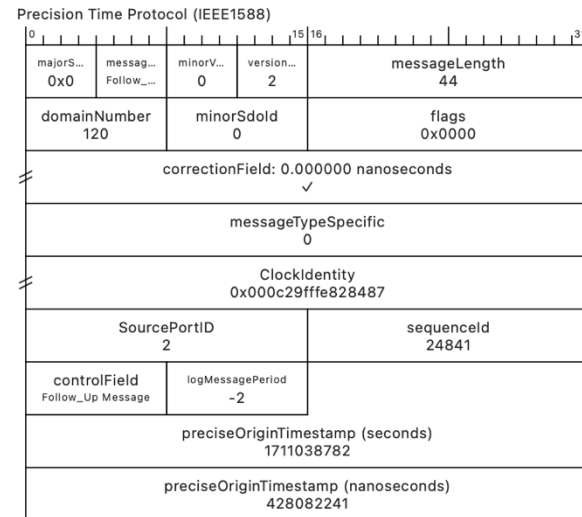
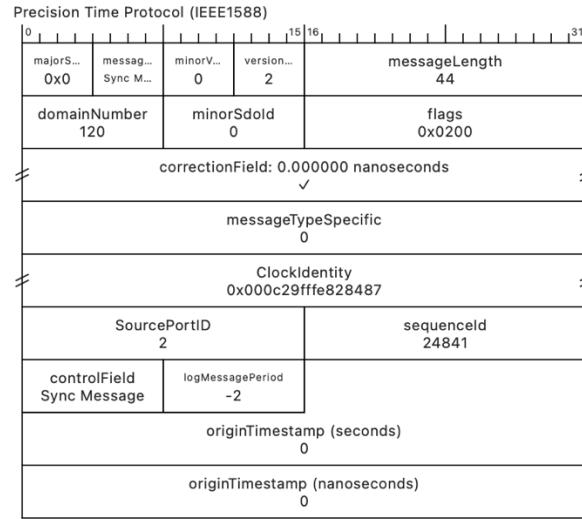

Delay Request

Delay Response

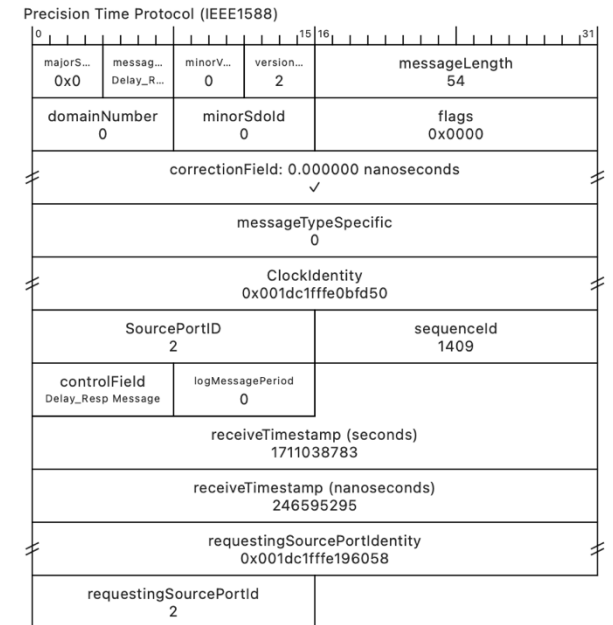
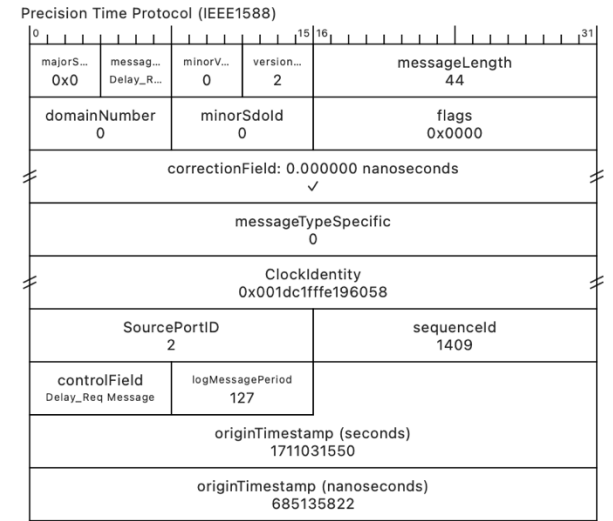

Jitter and Clocking

- If there's too much jitter, calculated times (t_{ms} and t_{sm}) will vary too much resulting in irregular clock offset adjustments.

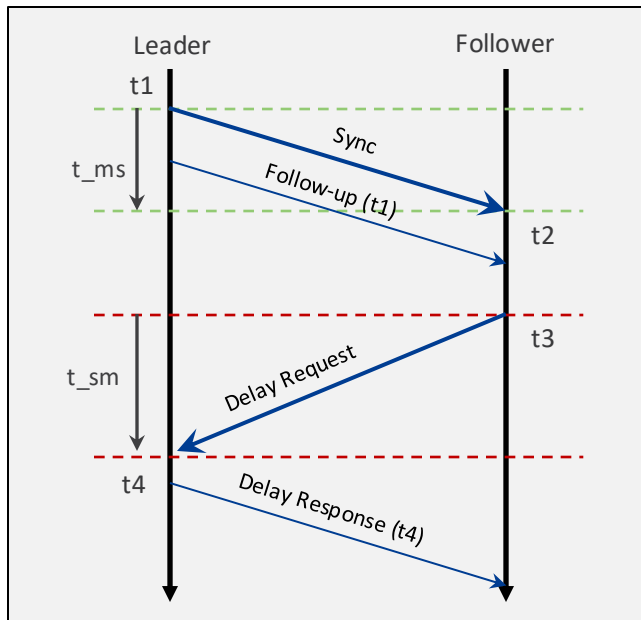

Sequence 1

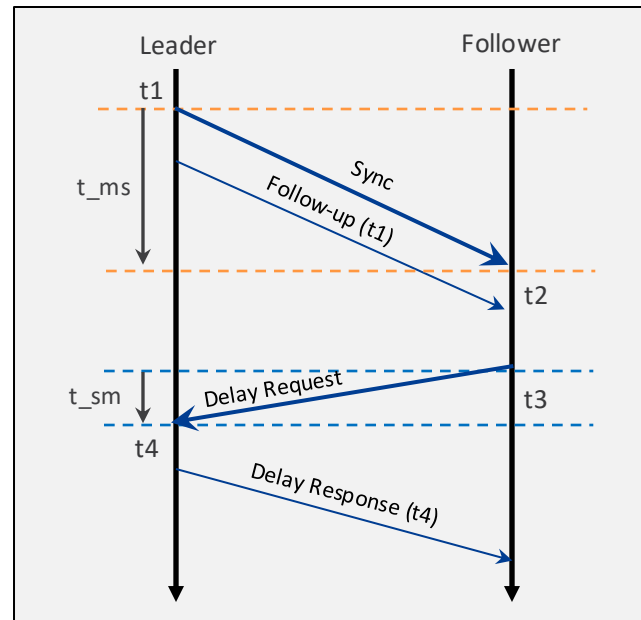

Sequence 2

$$\text{PTP Offset} = [(t_2 - t_1) - (t_4 - t_3)] / 2$$

PPM (Parts Per Million)

The frequency offset in DC is not the PTP offset/drift

The offset value in DC is calculated based on frequency difference and the correction applied to the follower internal control loop.

This value is presented in DC in PPM (parts per million); i.e. 1 part per million (worst case 1 sec gain/loss every 11.5 days).

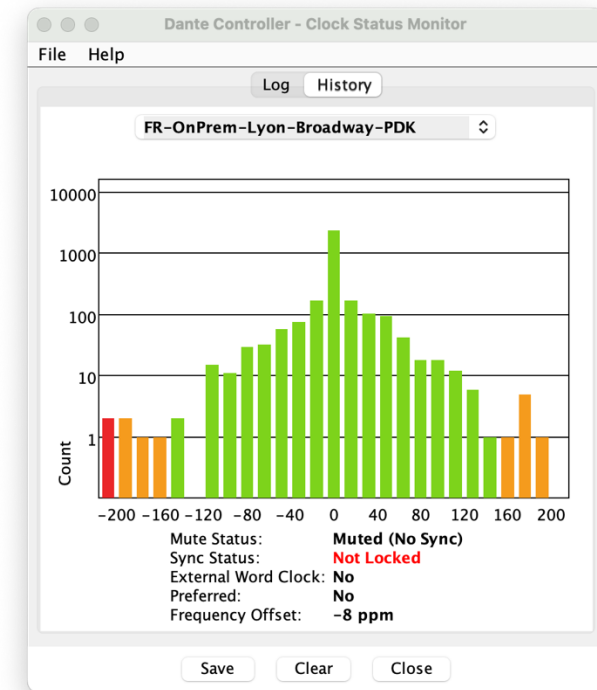















Jitter and Clocking

When PTP fails to achieve synchronization, Dante devices will mute.

This can be the case:

- over encrypted VPN links or locations connected with intermediate firewalls.
- on Energy Efficient Ethernet (EEE) switches.

Jitter Tolerances	
Dante Hardware	Up to 250us
Dante Software	Up to 1ms

FR-OnPrem-Lyon-BK3-64ch			Dante	Disabled	Follower
FR-OnPrem-Lyon-Broadway-PDK			Dante	Follower	Leader
FR-OnPrem-Lyon-DanteSDK-Zima2			Dante	Disabled	Follower
FR-OnPrem-Lyon-Gateway-NUC10VM			Dante	Disabled	Follower
FR-OnPrem-Lyon-Gateway-Zima1			Dante	Disabled	Follower
FR-OnPrem-Lyon-MIC			Dante	N/A	Follower
FR-OnPrem-Lyon-RedNet-AM2			Dante	Disabled	Follower

04

PTP







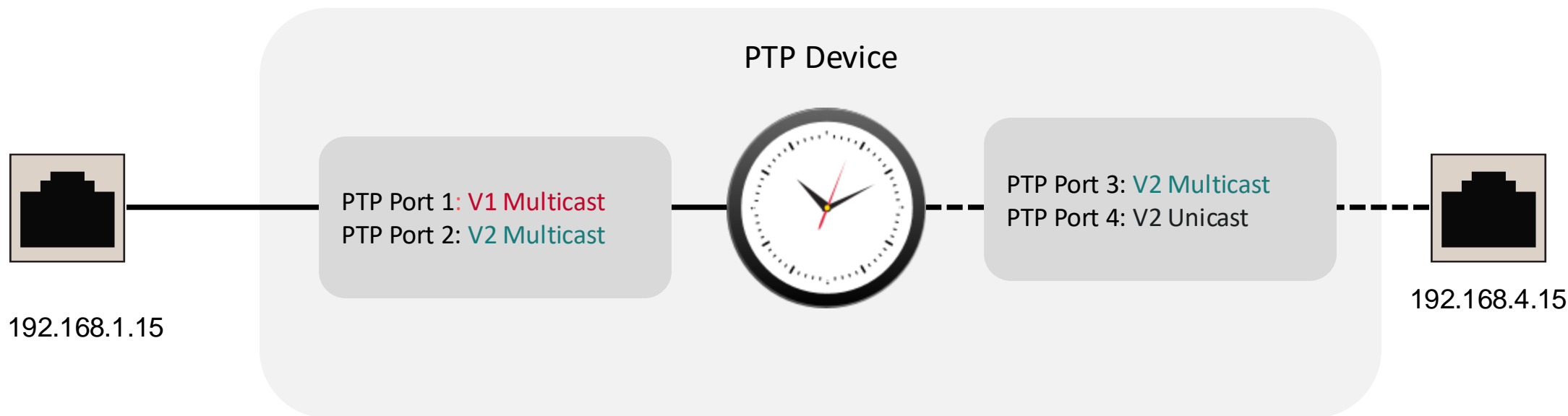





Organizational Principles

PTP Ports

- A PTP Port refers to an entity within a device that participates in PTP communication
- Multiple PTP ports can co-exist on a single NIC
- PTP Ports can have multiple states



IEEE 1588 PTP Ports States

Multicast	Unicast	State	Description
 	 	Leader	The port is the source of time on the path served by the port
		PreLeader	Transit state before becoming Leader
 	 	Follower	The port synchronizes with the device on the path on the port that is in the Leader state
		Listening*	Transit state before assuming a role
 	 	Passive/Standby	This state prevents timing loops at the PTP level

1. You can **NOT** be Follower on multiple ports
2. You **CAN** be Leader on multiple ports

PTP Clock types

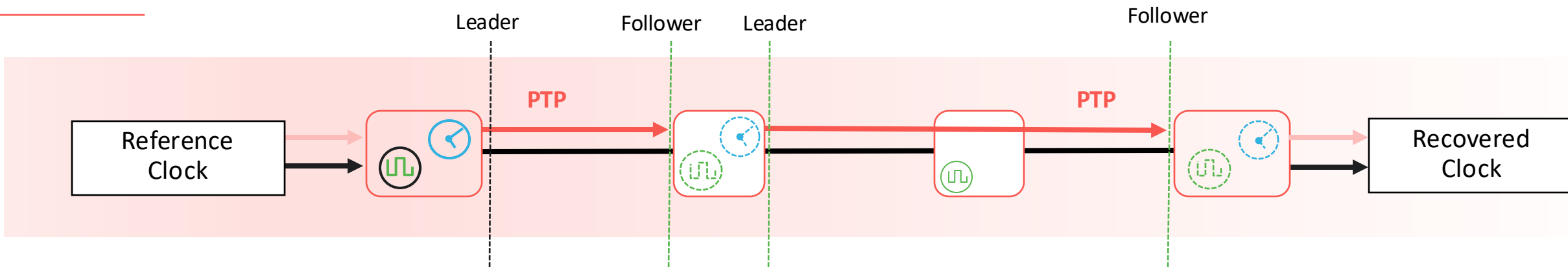

Grand Master Clock

- Primary reference source for all other PTP devices
- Highest-ranking clock in the network

Boundary Clock

- Has multiple PTP Ports
- Terminates the PTP flow, recovers the clock and regenerates a new PTP flow

Transparent Clock

- General switching device in a PTP aware network
- Can correct for queuing delay/resident delay

Ordinary Clock

- Single PTP Port Device
- Can act as Leader

Grand Master Clock Election: BMCA

The **Best Master Clock Algorithm (BMCA)** is a self configuring mechanism that will automatically pick the best Clock on a network segment to which other devices will be synchronized.

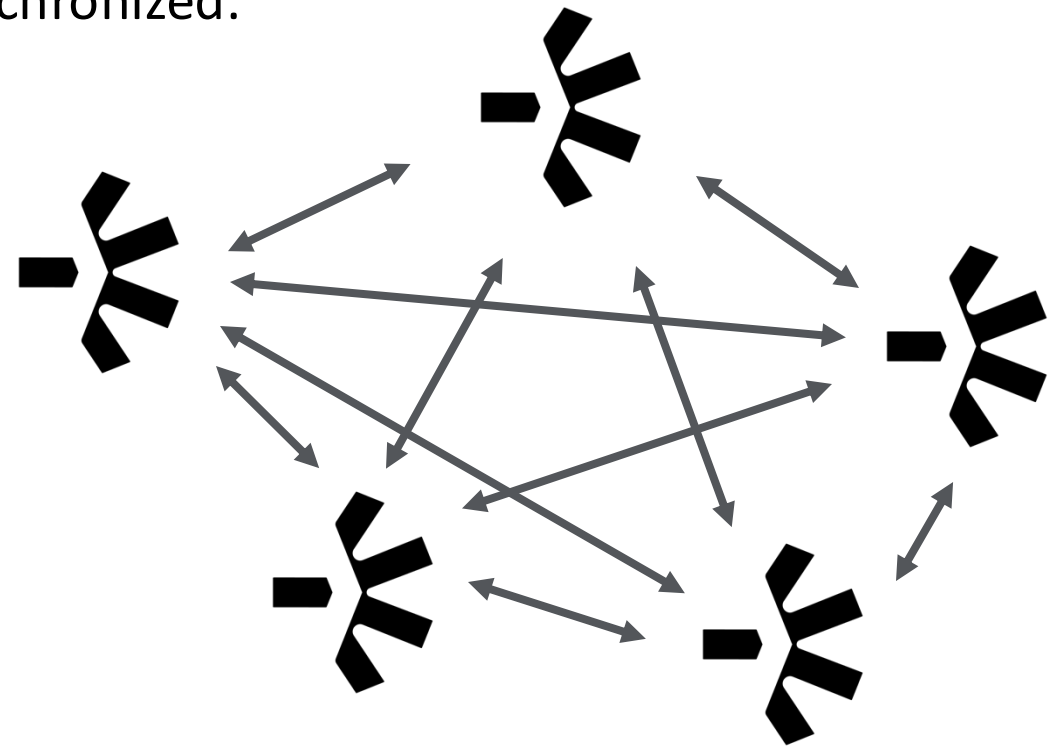

Grand Master Clock Election: BMCA state

BMCA runs continuously on each device and determines the status of each PTP port (Listening, Leader, Follower, etc.)

- **PTPv1**: is based on the content of the **Sync** message
- **PTPv2**: is based on the content of the **Announce** message

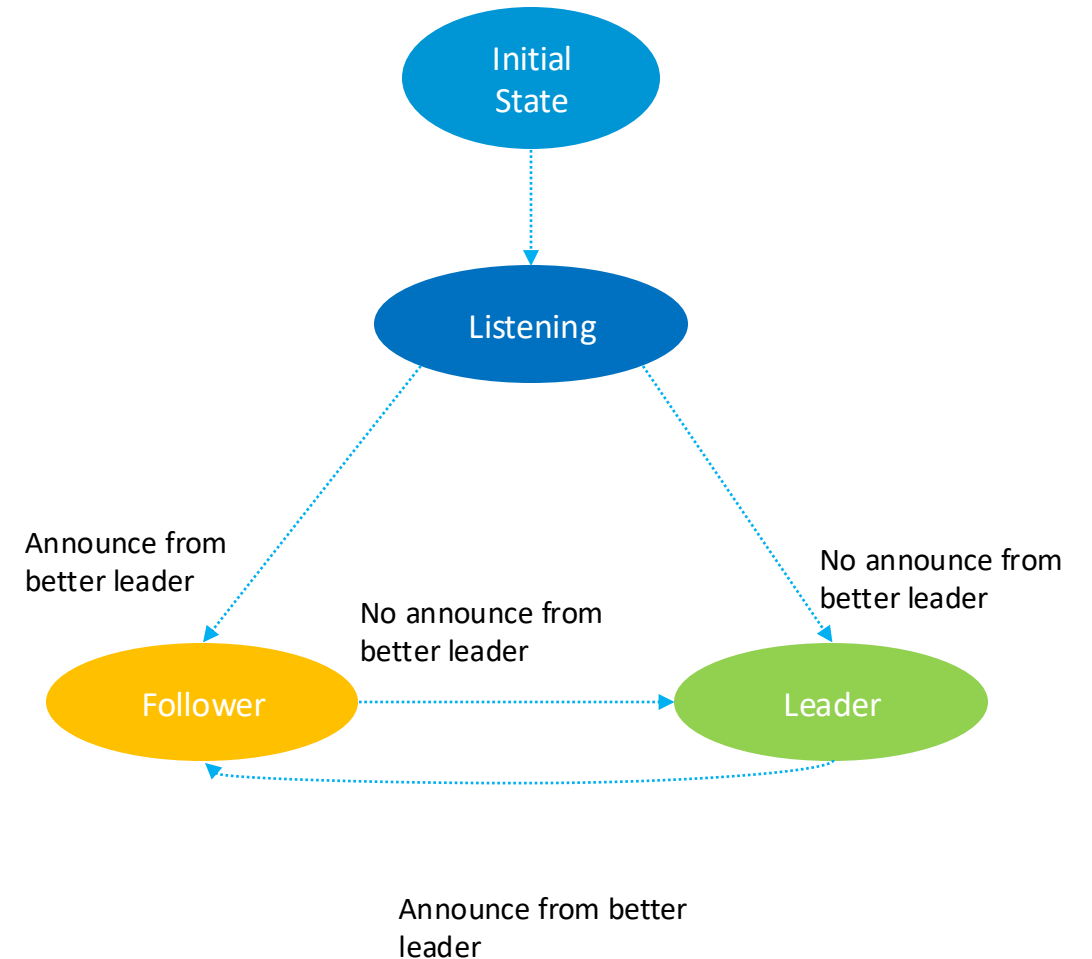





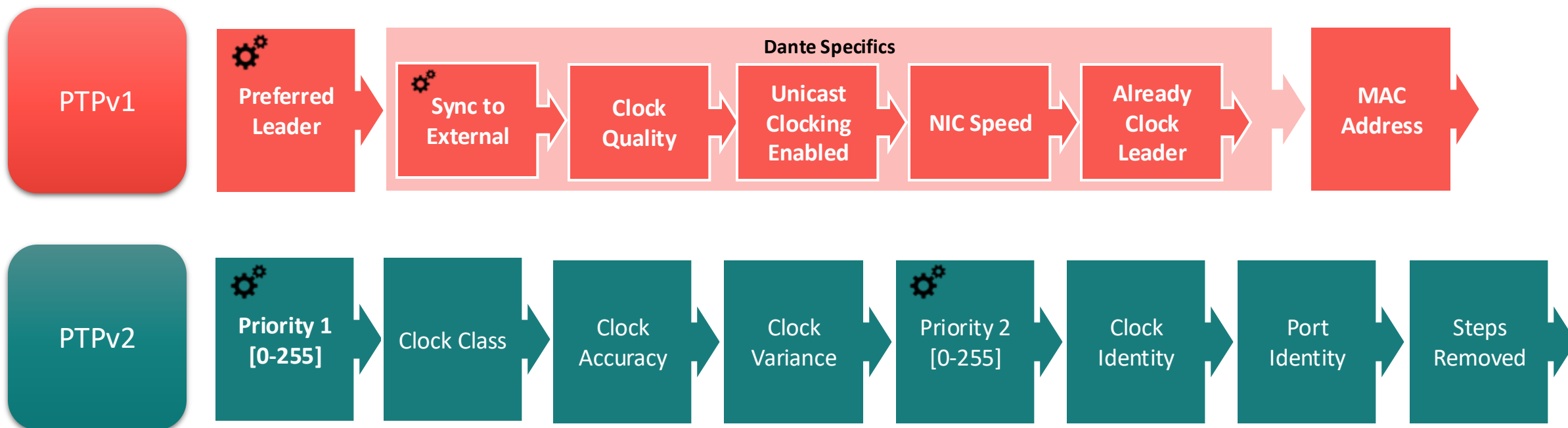



Grand Master Clock Election: BMCA

BMCA compares its own data set with the received data sets on different attributes for PTPv1 or PTPv2



Grand Master Support in Dante Devices

Dante Product	PTP v1	PTP v2
UltimoX AVIO Dante Pro S1	 Up to 40 Followers	 Unmanaged AES67 DDM (from fw 4.2)
Brooklyn II Broadway HC PCIe IP Core	 Up to 250 Followers	 Unmanaged AES67 DDM
Dante AV Ultra		 DDM
DEP Dante AV-H Dante AV-A	 Leader if no Dante Hardware	 Unmanaged AES67
Dante VIA Dante Studio Dante Virtual Soundcard Pro		 Unsupported
Dante Virtual Soundcard DAL	 Follower only	

Ordinary Clocks

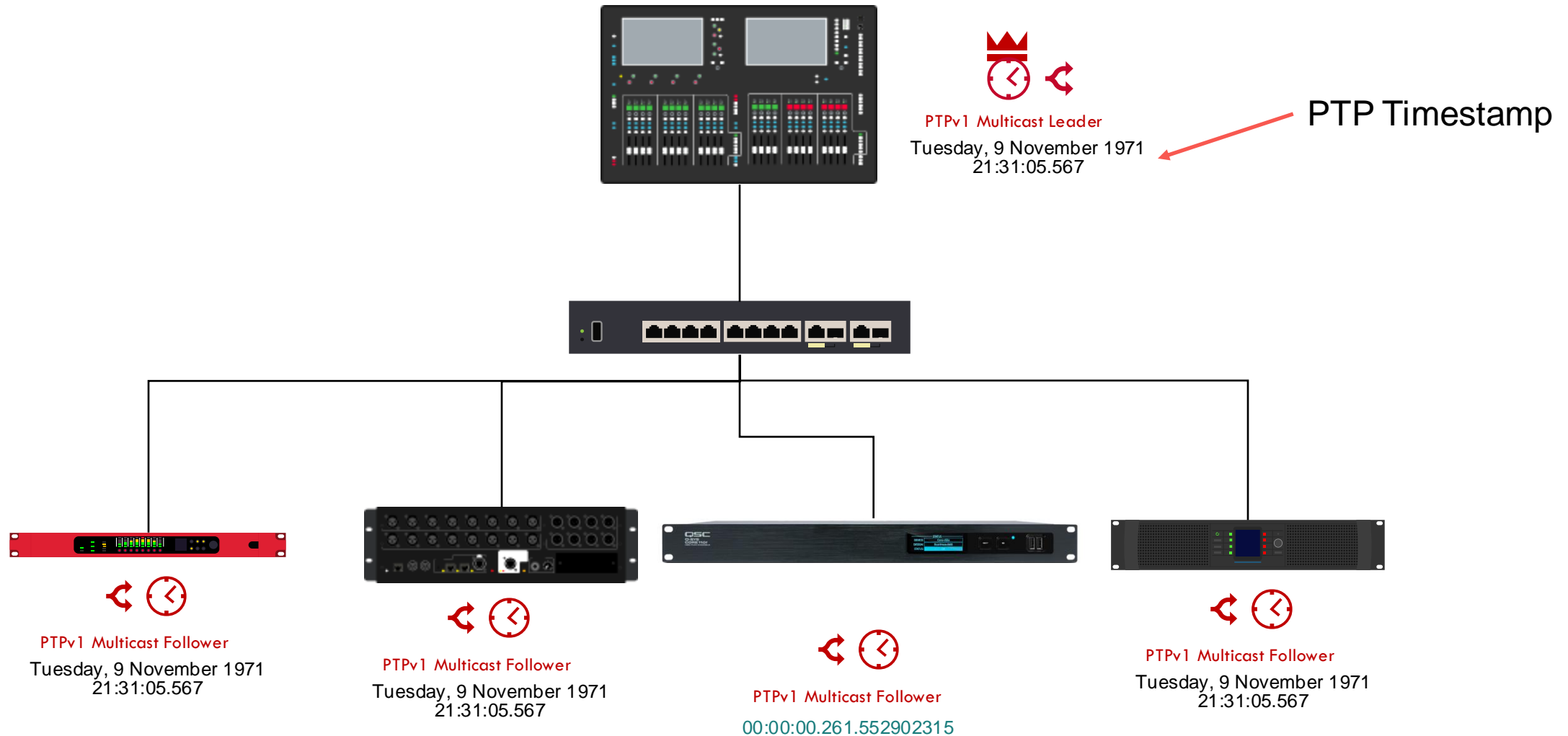

On hardware devices, it is the time since the Unix Epoch (January 1, 1970)

On software devices, it is **simply the value of the monotonic counter**

Boundary Clocks: Redundant Dante Devices

1. Redundant Dante Devices have multiple PTP Ports
2. The device internal clock can be potentially driven from both PTP Ports
3. PTP Ports on the Primary Network have higher priority than those on the Secondary Network

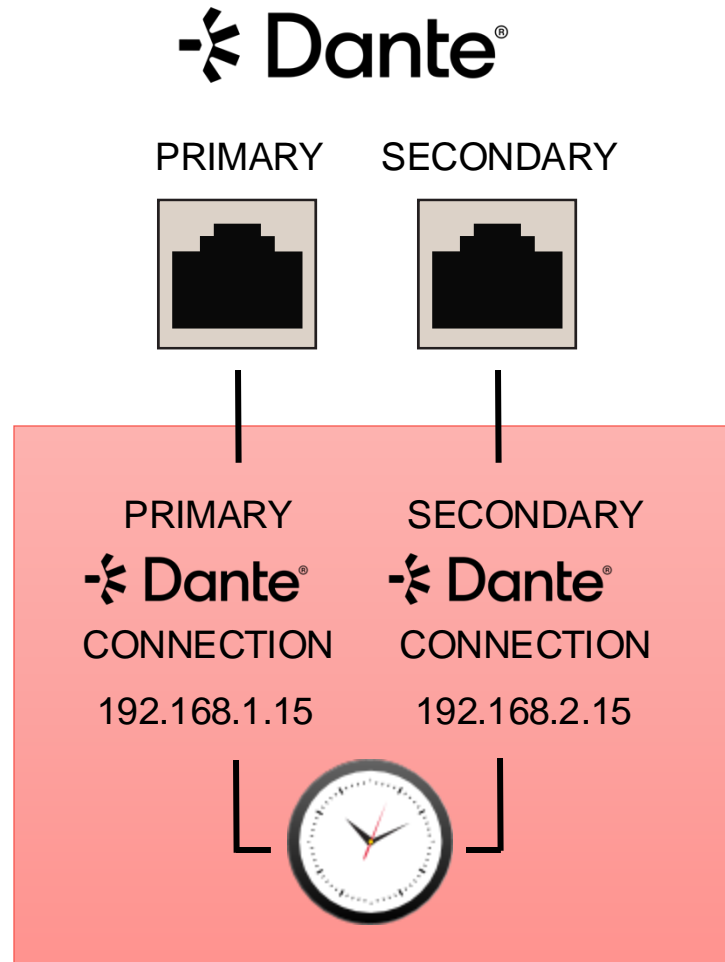

Boundary Clocks: Redundant Dante Devices

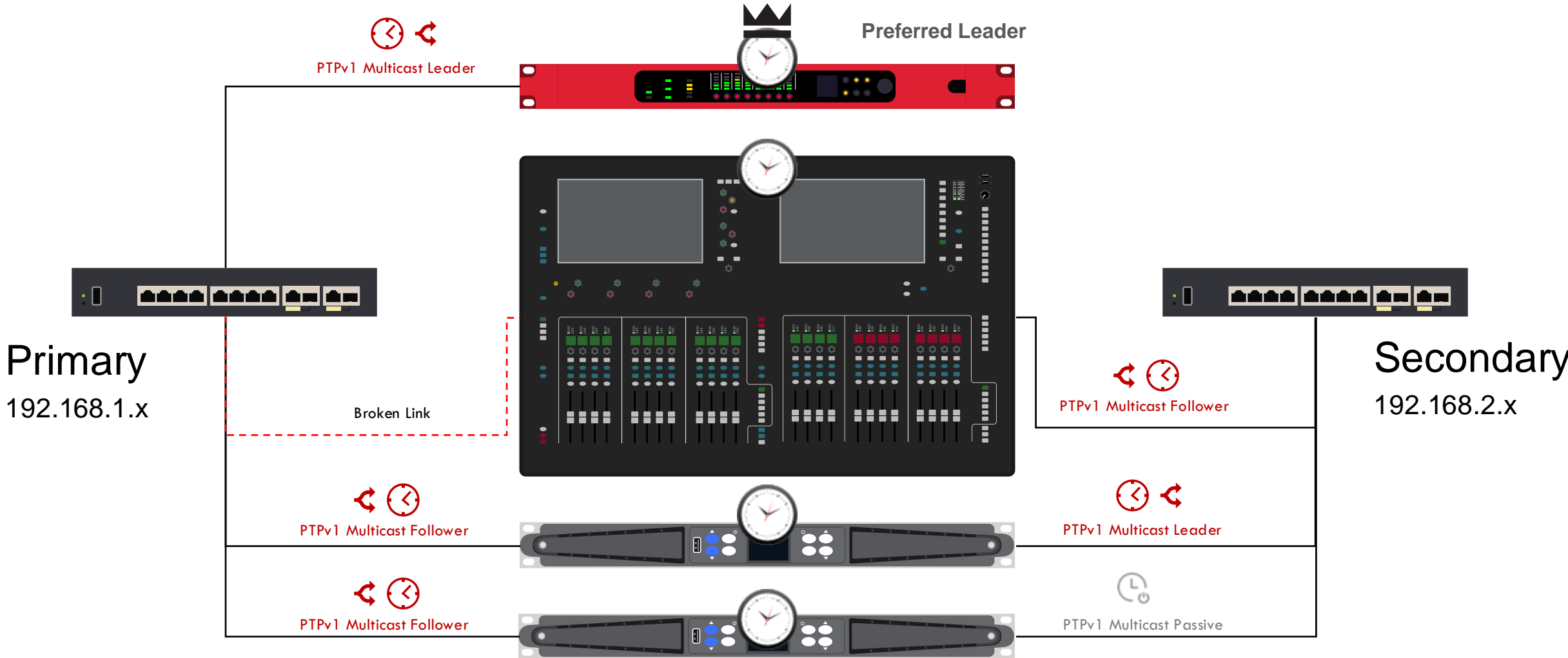

Boundary Clocks: Multicast PTPv1 & PTPv2

Dante devices with supported firmware can act as Boundary Clocks between PTPv1 and PTPv2 in multiple situations:

1. Unmanaged AES67 networks
2. Managed Networks with Dante Domain Manager
 1. Native Dante v1 + v2
 2. AES67
 3. SMPTE 2110

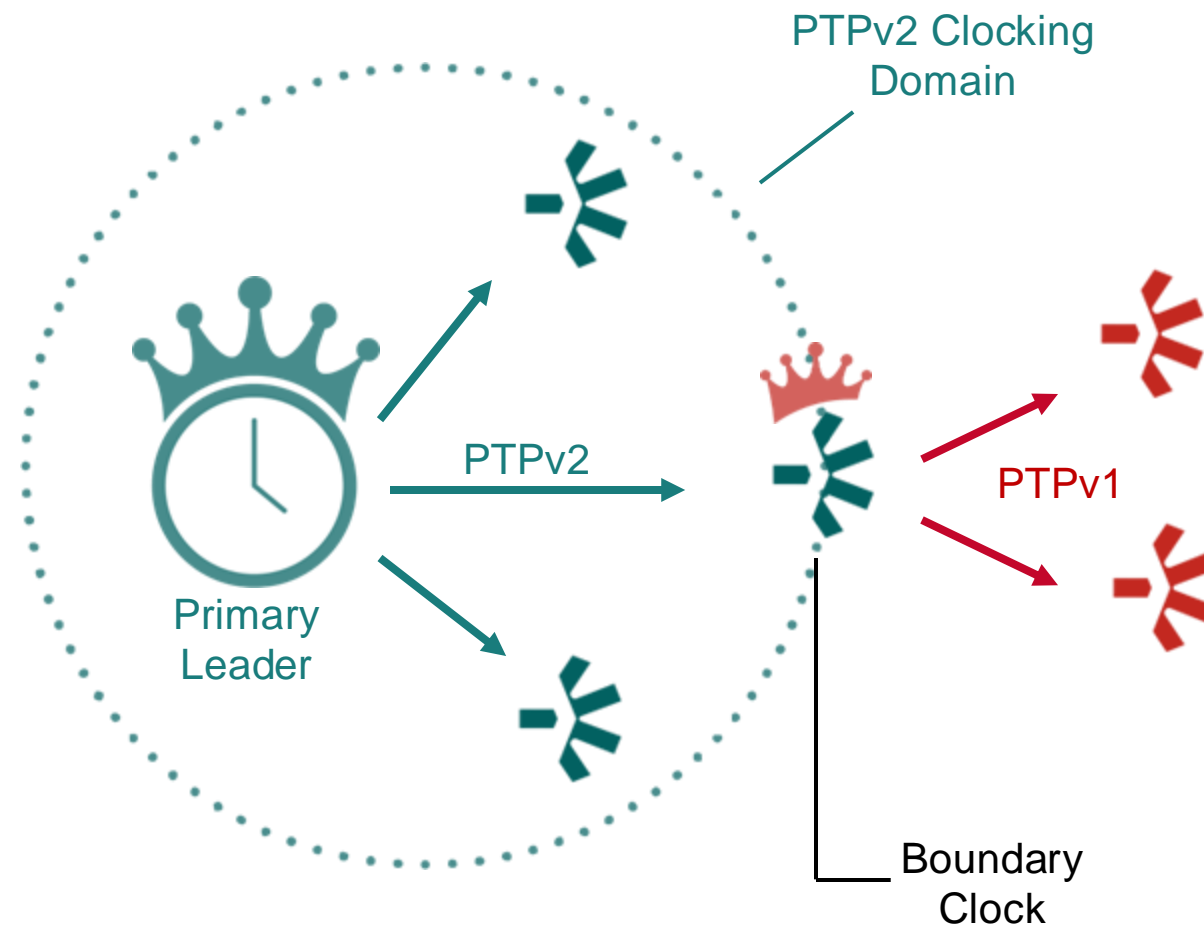

Boundary Clocks: Multicast PTPv1 & PTPv2

Using an external PTPv2 Grand Master

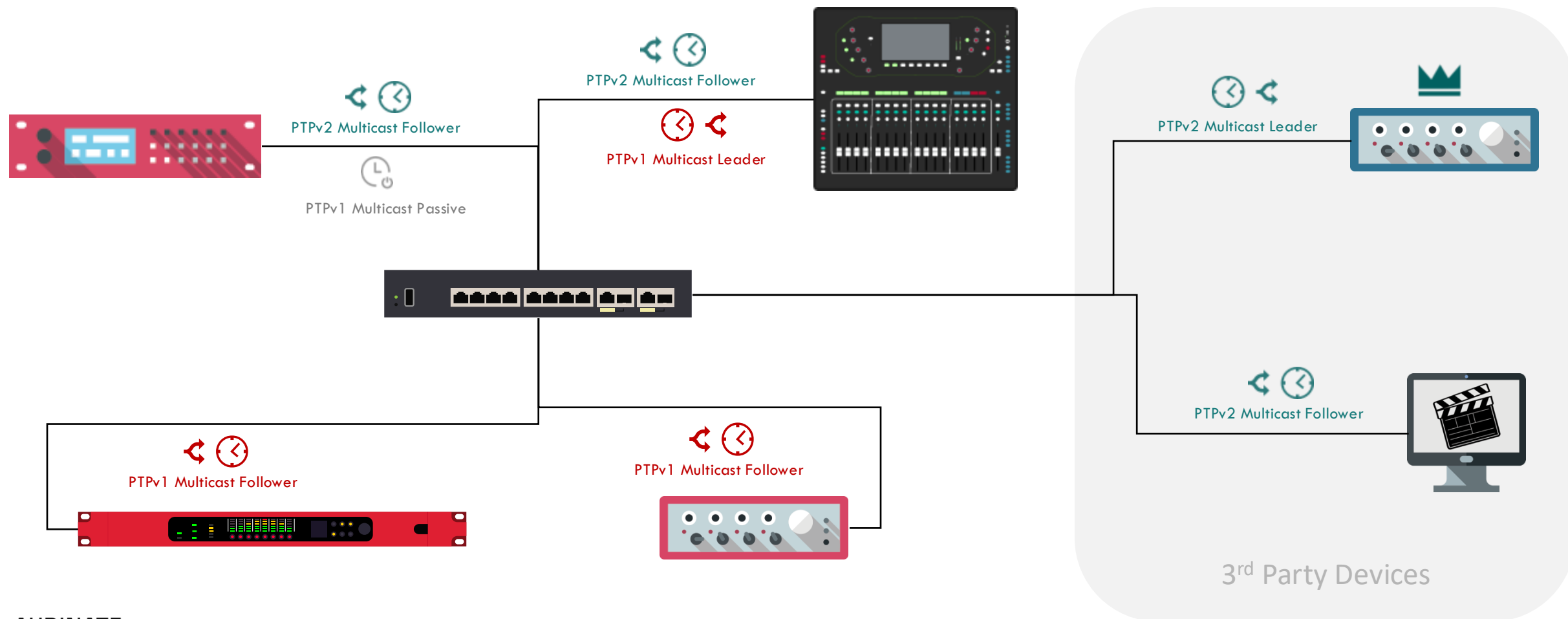

Boundary Clocks: Multicast PTPv1 & PTPv2

Dante as the PTPv2 Grand Master

PTPv1 has priority over PTPv2 between Dante Devices

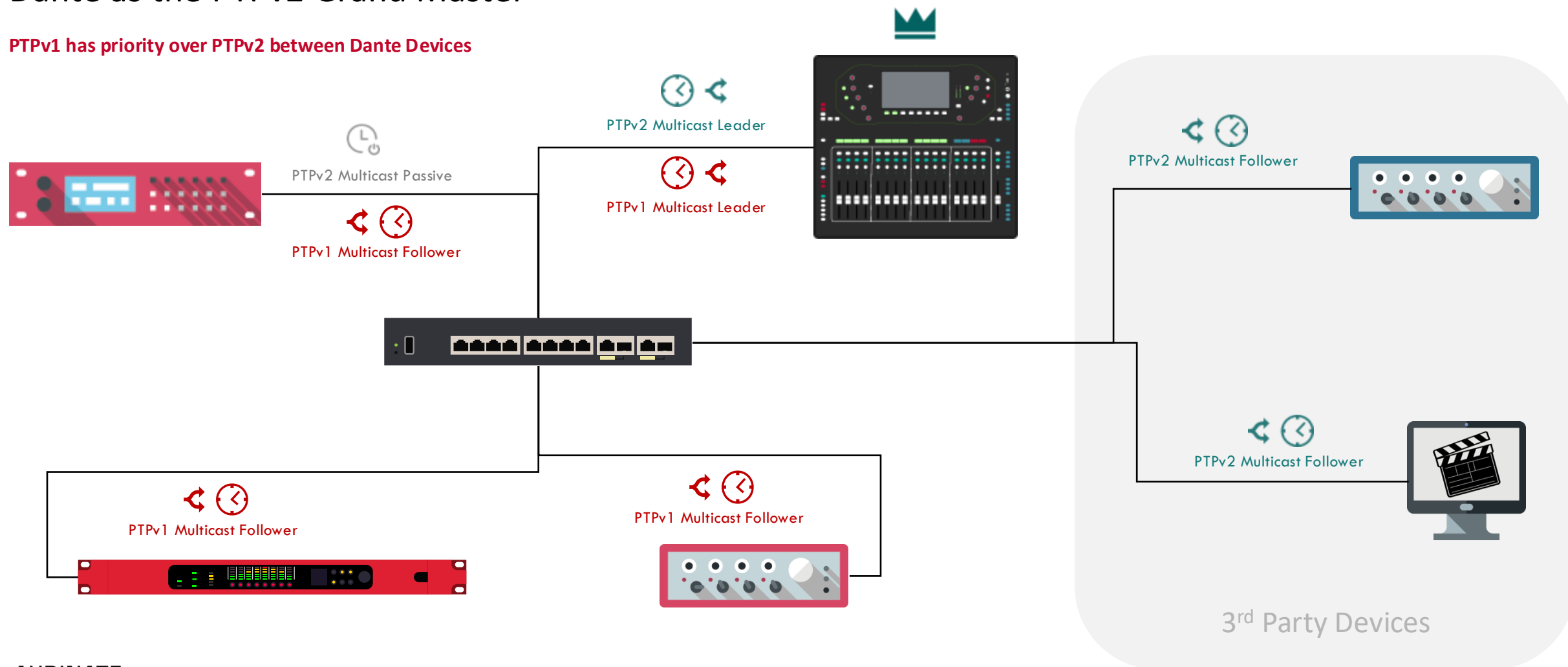

Boundary Clocks: Multicast PTPv1 & PTPv2

Redundant Networks

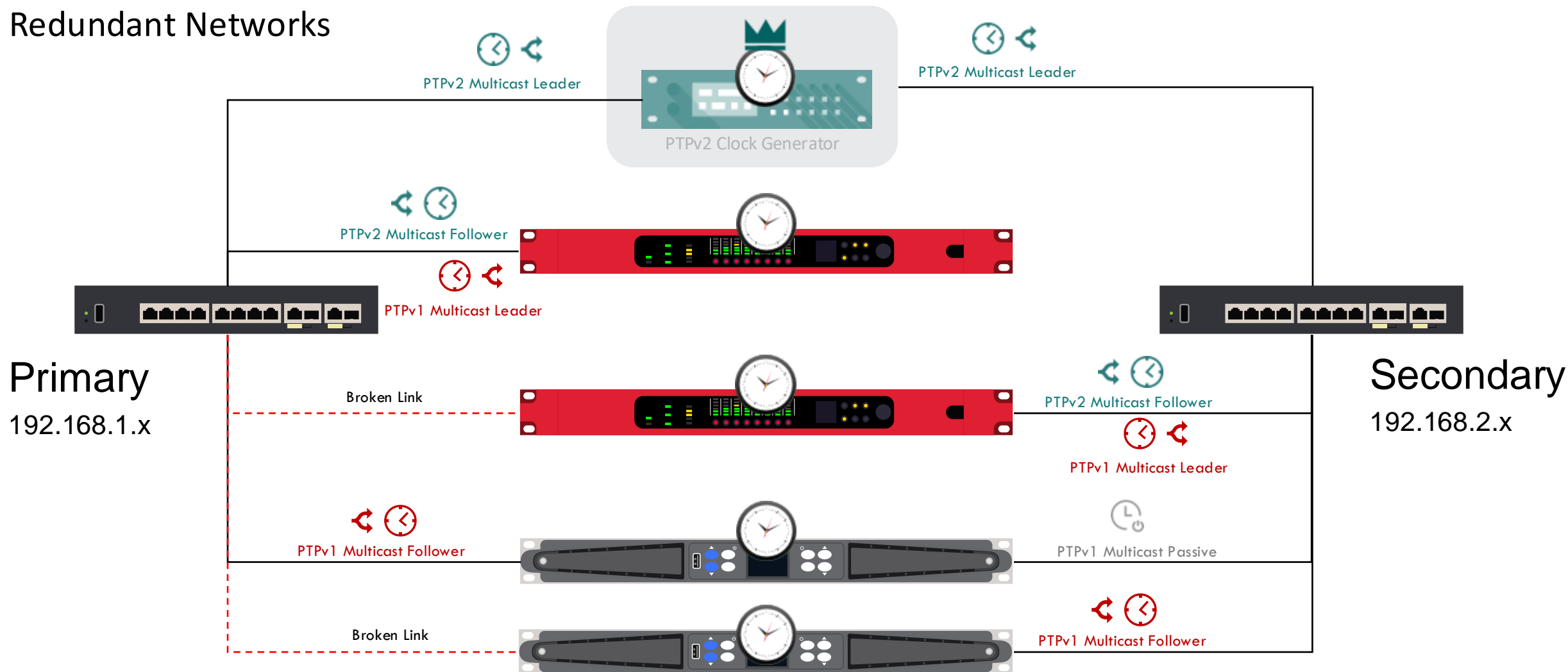

Boundary Clocks: Unicast PTPv2

Supported by all Hardware Dante* devices on Managed Networks (Dante Domain Manager or Dante Director)

- Unicast Clocking is only available on the Primary Port
- Unicast Clocking is reflected under the *Domain Status* column on the Dante Controller Clock tab.

Domain Clocking

Subnet 10.102.21.0/24 ASSIGN ZONE

DEVICE NAME	STATUS	UNICAST CLOCKING	CUSTOMIZE CLOCKING
Campus-PA-North		<input checked="" type="checkbox"/>	Customize
Campus-PA-South		<input checked="" type="checkbox"/>	
Campus-PA-Parking		<input type="checkbox"/>	

Subnet 10.102.22.0/24

DEVICE NAME	STATUS	UNICAST CLOCKING
Office-PA-Level-1		<input checked="" type="checkbox"/>
Office-PA-Level-2		<input checked="" type="checkbox"/>
Office-PA-Parking		<input type="checkbox"/>

Shared Audio Clocking

Subnet 10.15.28.0/24

Device Name ^	Status	Unicast Clocking	Preferred Leader
Uni-PA-North-Parking-A		<input type="checkbox"/>	<input type="checkbox"/>
Uni-PA-North-Parking-B		<input type="checkbox"/>	<input type="checkbox"/>

Subnet 10.15.29.0/24

Device Name ^	Status	Unicast Clocking	Preferred Leader
Uni-PA-South-Parking-A		<input type="checkbox"/>	<input type="checkbox"/>
Uni-PA-South-Parking-B		<input type="checkbox"/>	<input type="checkbox"/>

Dante Controller - Network View

File Devices View Help

Primary LD... Public Announcement lucas.moreno@audinate ?

Routing Device Info **Clock Status** Network Status Events

Device Name	Sync	Mute	Clock Source	Domain Status	Primary v1 Multicast	Primary v2 Multicast	Secondary v1 Multicast	Secondary v2 Multicast
10.15.28.0/24								
Uni-PA-North-Parking-A			Dante	Leader	Leader	Disabled	N/A	N/A
Uni-PA-North-Parking-B			Dante	Standby	Follower	Disabled	N/A	N/A
10.15.29.0/24								
Uni-PA-South-Parking-A			Dante	Follower	Leader	Disabled	N/A	N/A
Uni-PA-South-Parking-B			Dante	Standby	Follower	Disabled	N/A	N/A

Boundary Clocks: Unicast PTPv2

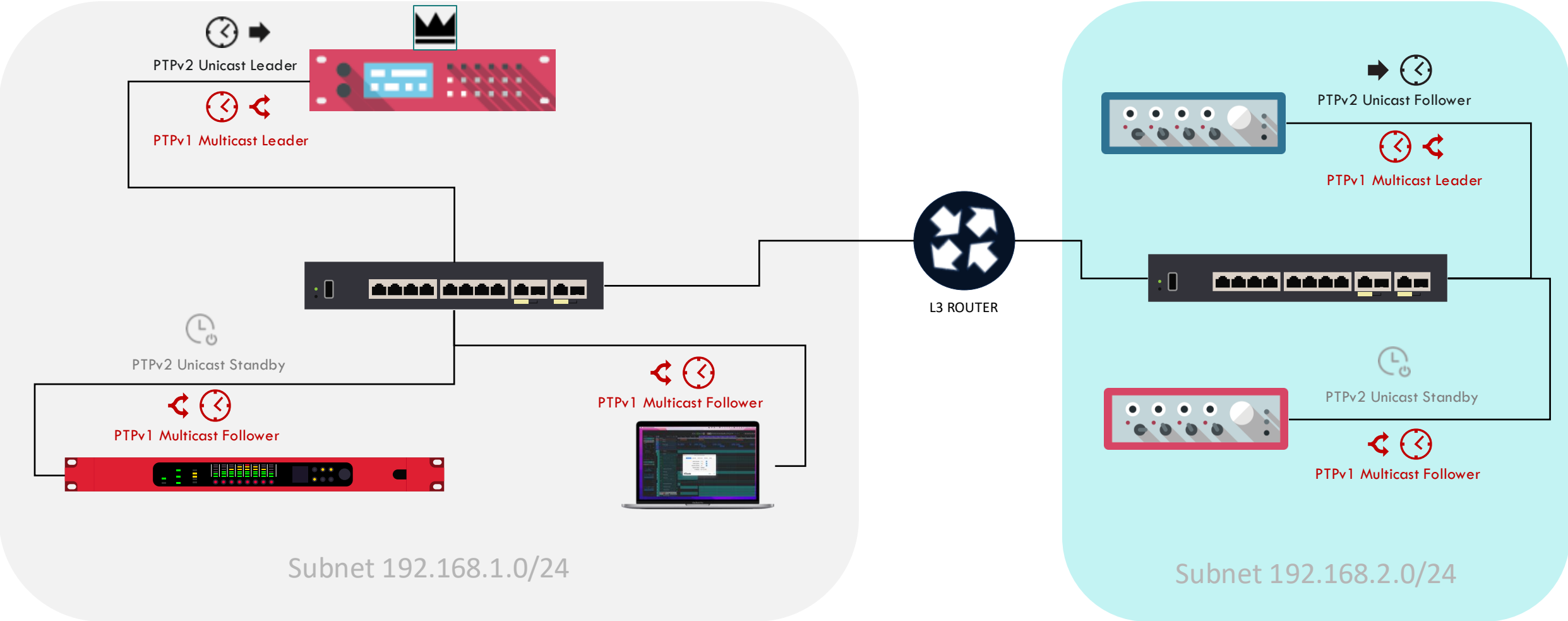

Boundary Clocks: Multicast & Unicast PTPv1+v2

Hybrid clocking configurations can be achieved under Dante Domain Manager for PTPv2 or AES67 or SMPTE Domains

1. Overall Clocking structure needs to expand like a tree from the Grandmaster
2. It's OK to have dormant clocks or redundant links

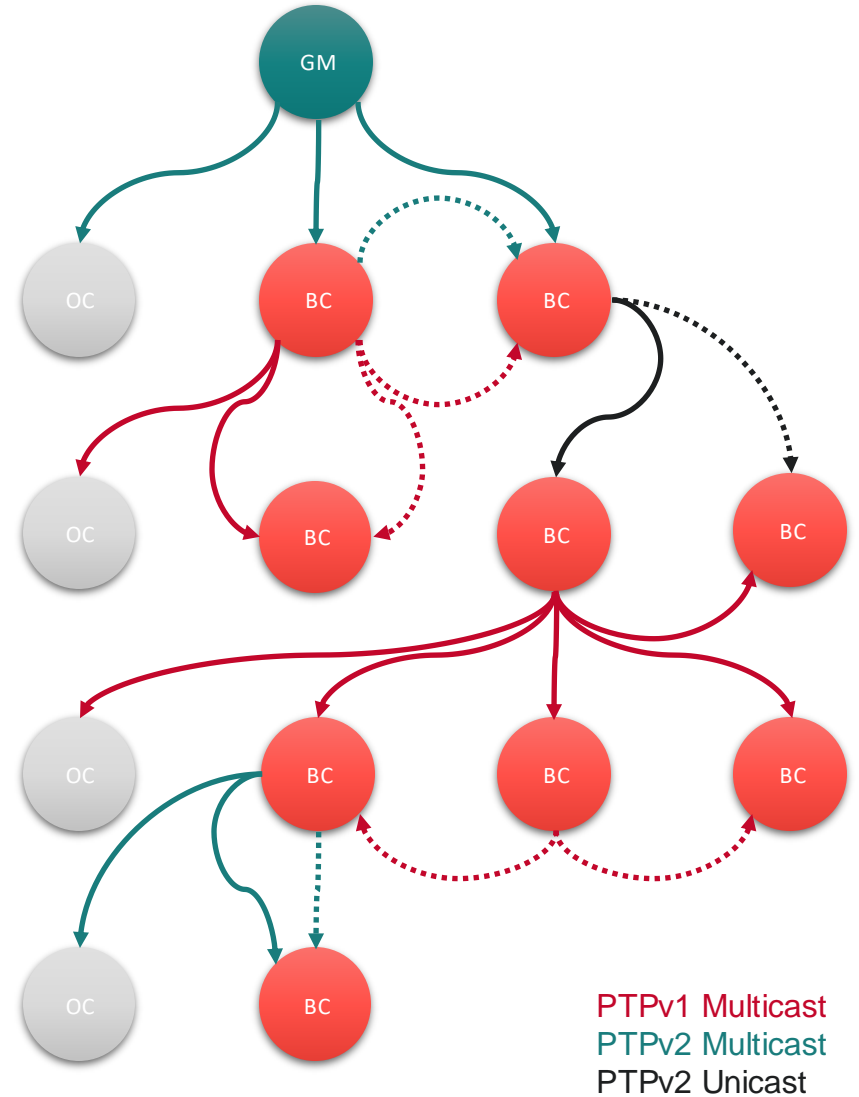

Boundary Clocks: Unicast PTPv2

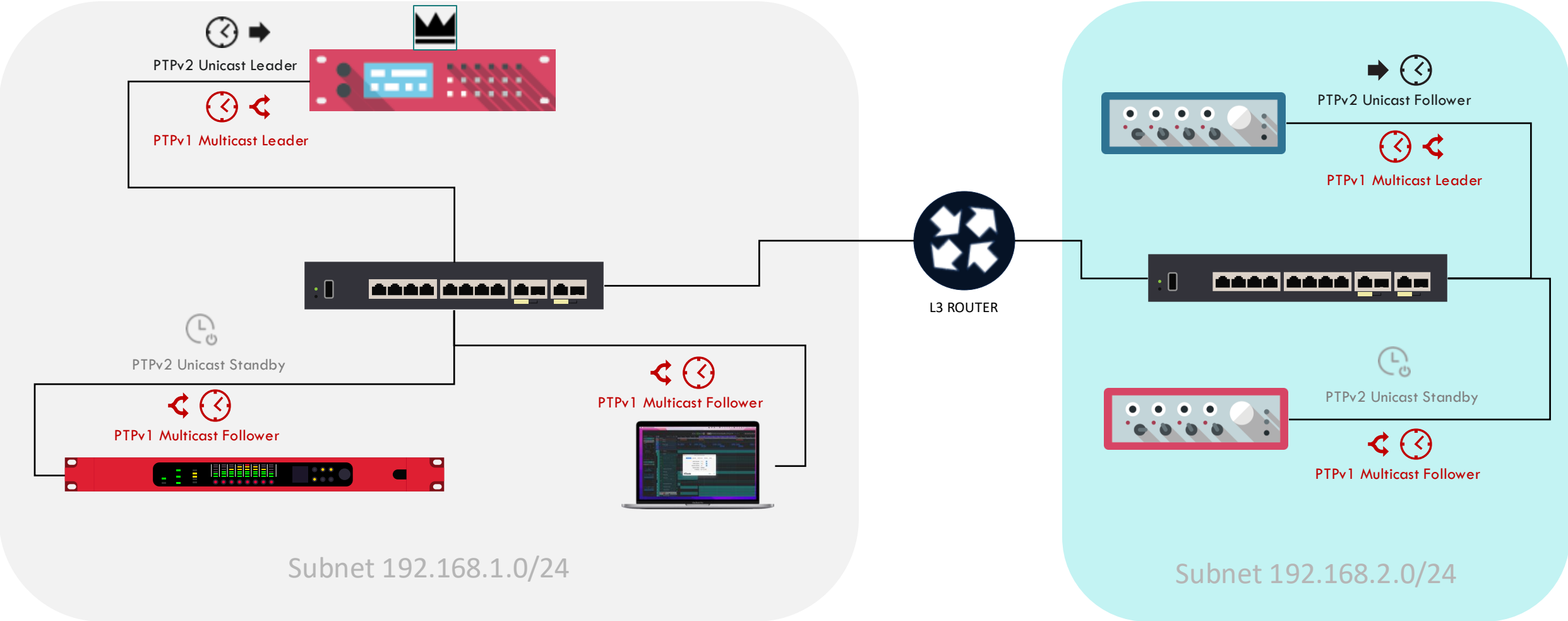

Boundary Clocks: Dante Devices as 5 Port PTP Devices

Compatible Dante Devices can run up to 5 PTP Ports over the Primary and Secondary NICs

Depending on the Network / PTP Topology:

1. Multiple Ports can be Leader / Passive
2. A single Port can be Follower

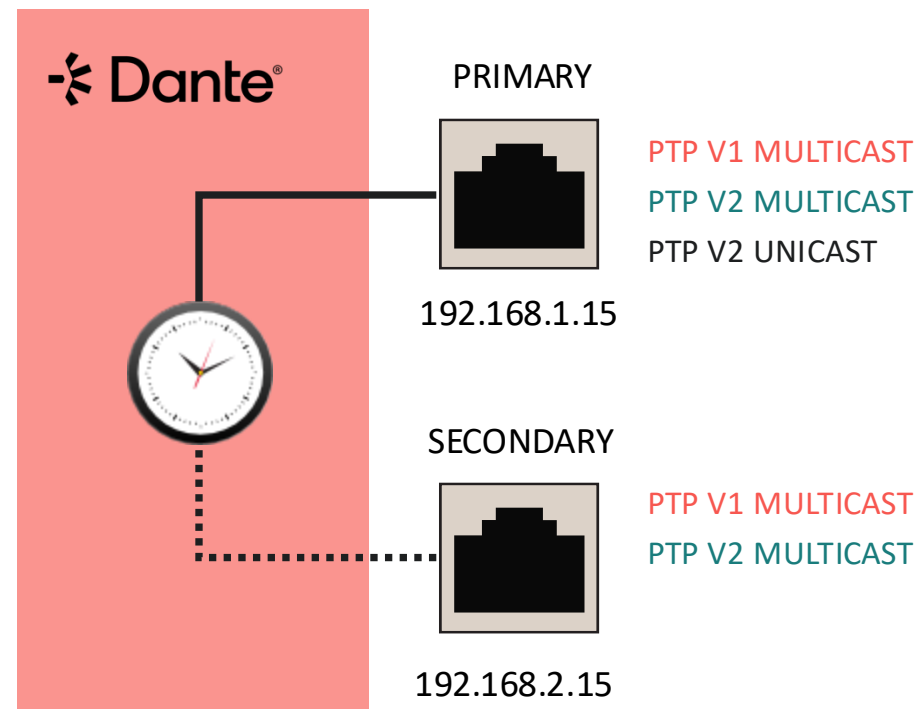

1. You can **NOT** be Follower on multiple ports
2. You **CAN** be Leader on multiple ports

05 Additional PTP Information

PTP Domains/Subdomains

PTP Domains/Subdomains are logical groups of PTP devices that synchronize to each other using the PTP protocol

	PTPv1 Subdomain (automatic)	PTPv2 Domain (can be user settable)
Default Dante AES67 Mode	_DFLT	0
Pull-up/down DDM	_ALT1	1
	_ALT2	2
	_ALT3	3
DDM	Custom value Ex: "H~OSL"	4 ~ 255

PTP Transport & Packet Details

		PTPv1	PTPv2
Layer 4	UDP	Port 319 (Event Messages) Port 320 (General Messages)	
Layer 3	DiffServ	CS7 #56 (Event Messages) EF #46 (General Messages)	EF #46 (All messages)
	IPv4 Multicast	224.0.1.129 (default subdomain) 224.0.1.130-132 (pull-up/down or DDM subdomains)	224.0.1.129
		TTL=1	TTL=16 (configurable)
	IPv4 Unicast	Unicast Delay Request/Response	All messages (Unicast clocking)
Layer 2	Ethernet	0x88F7 (Ethertype field) 01:1B:19:00:00:00/01:80:C2:00:00:0E (Ethernet multicast address)	

PTPv2 Profiles and Dante

“The purpose of a PTP profile is to allow organizations to specify a specific selection of PTP parameter values and optional features that work together...”

Among the other PTP profiles for Telecom, Power, gPTP (802.1AS)... we can mention*:

Profile	AES67 profile	SMPTE 2059-2 profile
Defined by	AES67-2018 Annex A, the Media profile for AES67	ST 2059-2, the Media profile for ST 2110
Priority 1 & 2	Device specific (configurable in DDM)	0 ~ 128 ~ 255
Domain	0	0 ~ 127
Transport	Multicast	Multicast
Announce Interval	0	-3 ~ -2 ~ +1
Sync Interval	-2	-7 ~ -3 ~ -1

06

Scaling PTP: Large/Distant Networks

PTP is usually Multicast

Multicast can be a 1:N or N:N relationship.

On large networks, PTP can become very chatty:

1. The **Sync** and **Follow-up** messages from the Leader are sent to everyone (1:N) but this is **OK**
2. However, all the **Delay Request** and **Delay responses** between each of the Followers and the Leader are also seen by everyone else (N:N)

This is due to all PTP messages being sent to the same PTP Multicast addresses.

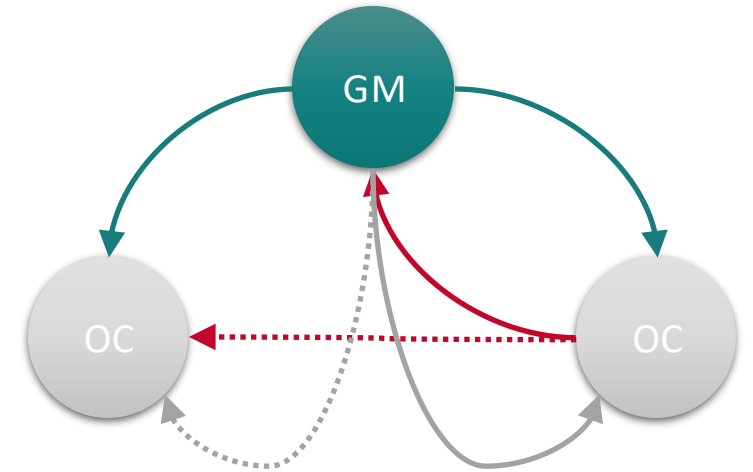

Sync / Follow Up
 Delay Request
 Delay Response

Better PTP Multicast Management

PTP Multicast N:N traffic can be reduced by:

1. Using the Unicast Delay request in Dante Devices (**PTPv1** only)
2. Deploying **PTPv2** aware networks with Switches acting as Boundary Clocks

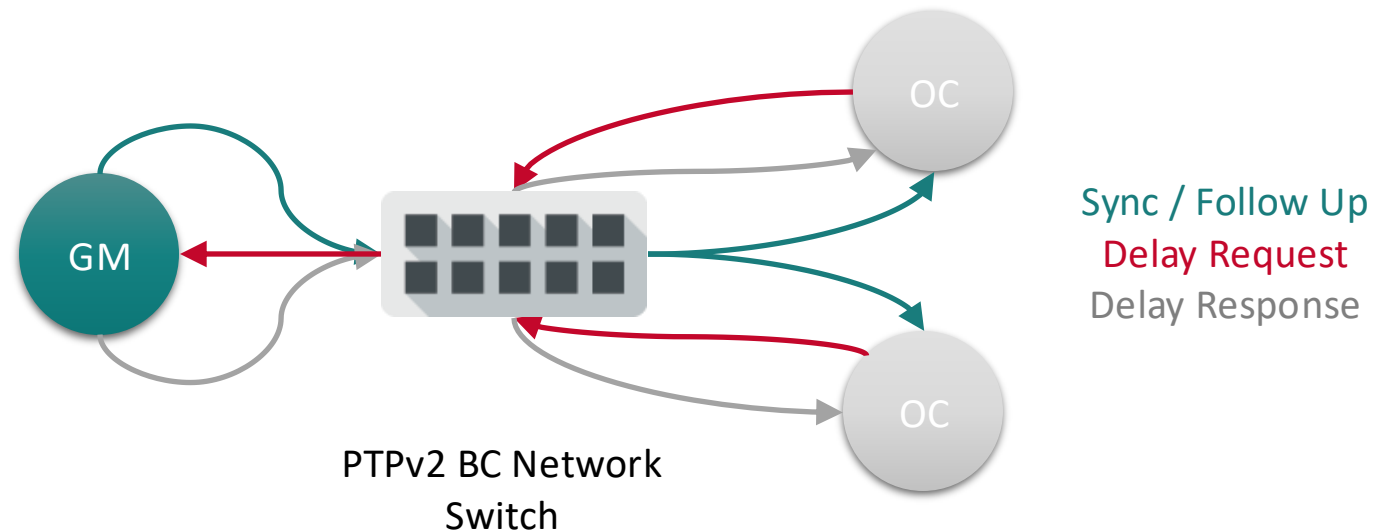
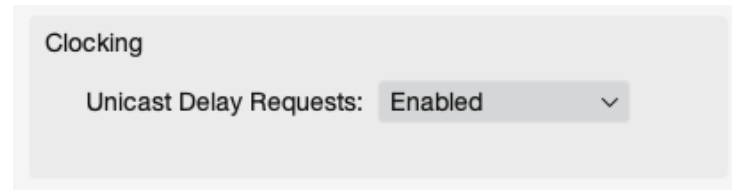

PTPv2 Aware Networks

All the network switches are Boundary Clocks that participate on the PTP distribution

Port states:

- Leader
- Follower
- Passive

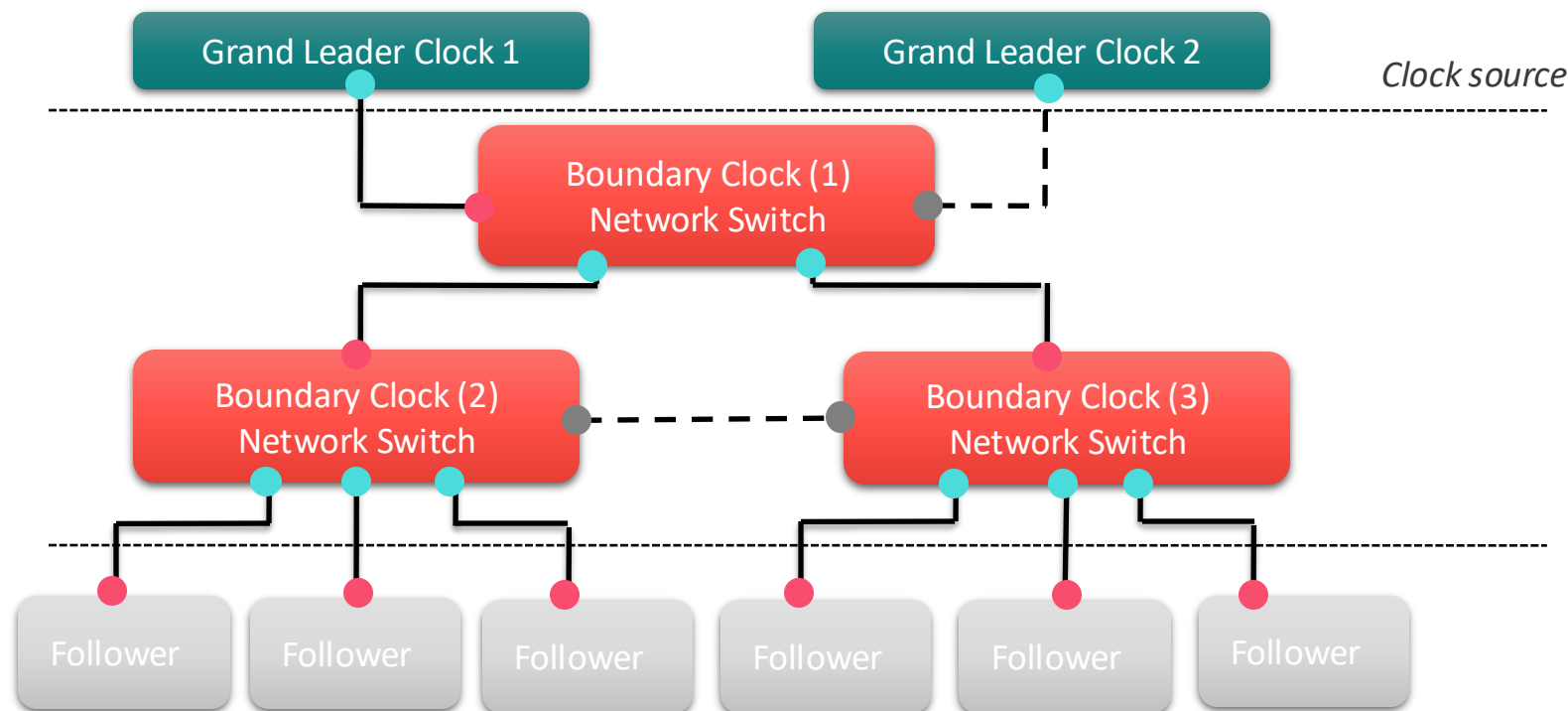

DDM Clock Zoning

Clock zoning is a feature available on Dante Domain Manager managed networks.

1. Subnets can be assigned into different Clocking Zones.
2. PTPv2 Unicast clocking will be disabled between Zones.
3. Clocking distribution between zones is to be managed externally

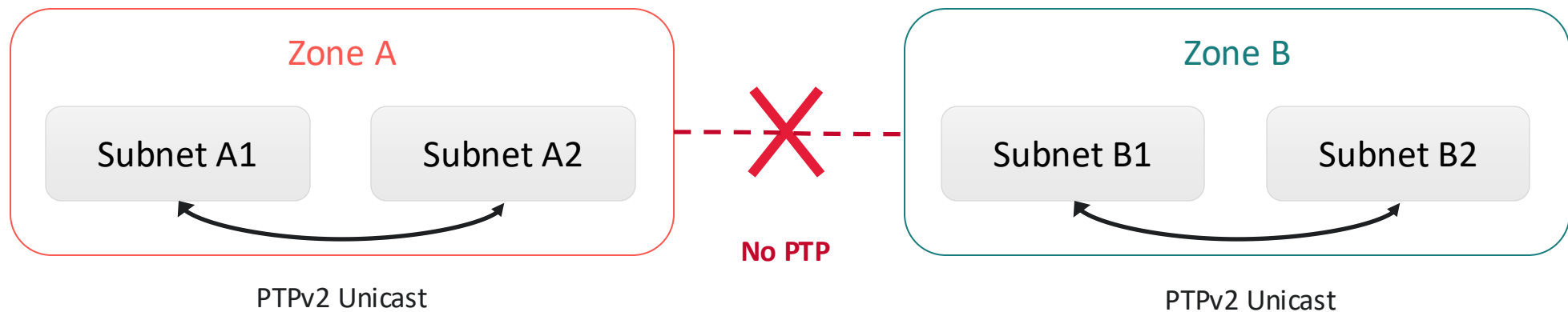
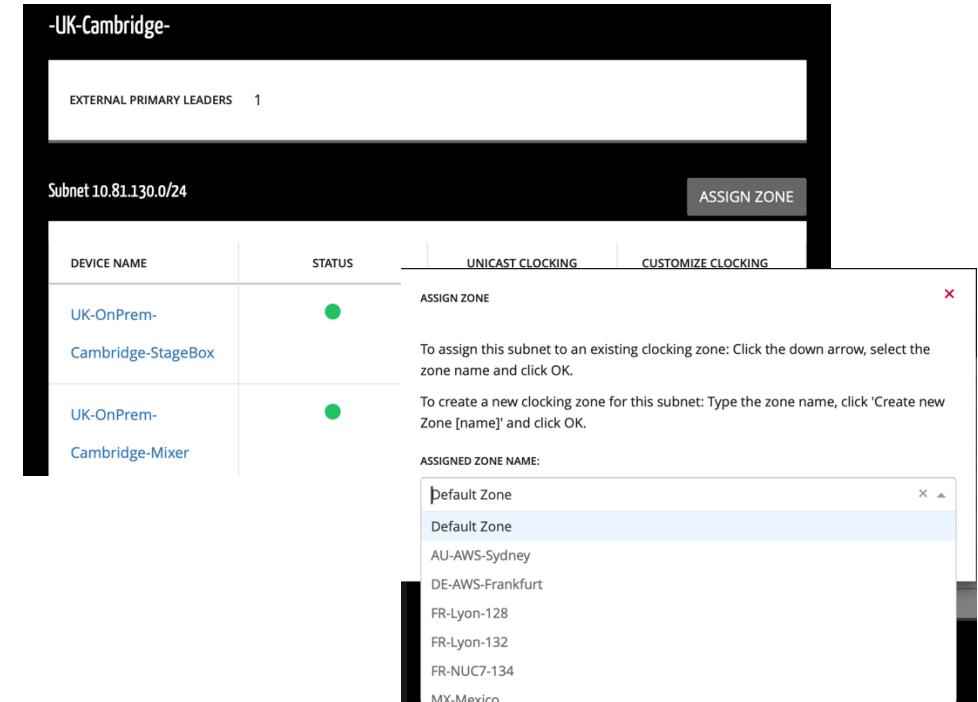

DDM Clock Zoning: GPS distribution

GPS enabled Grand Master devices on each Zone:

GPS
PTPv2 Multicast
PTPv1 Multicast
Audio

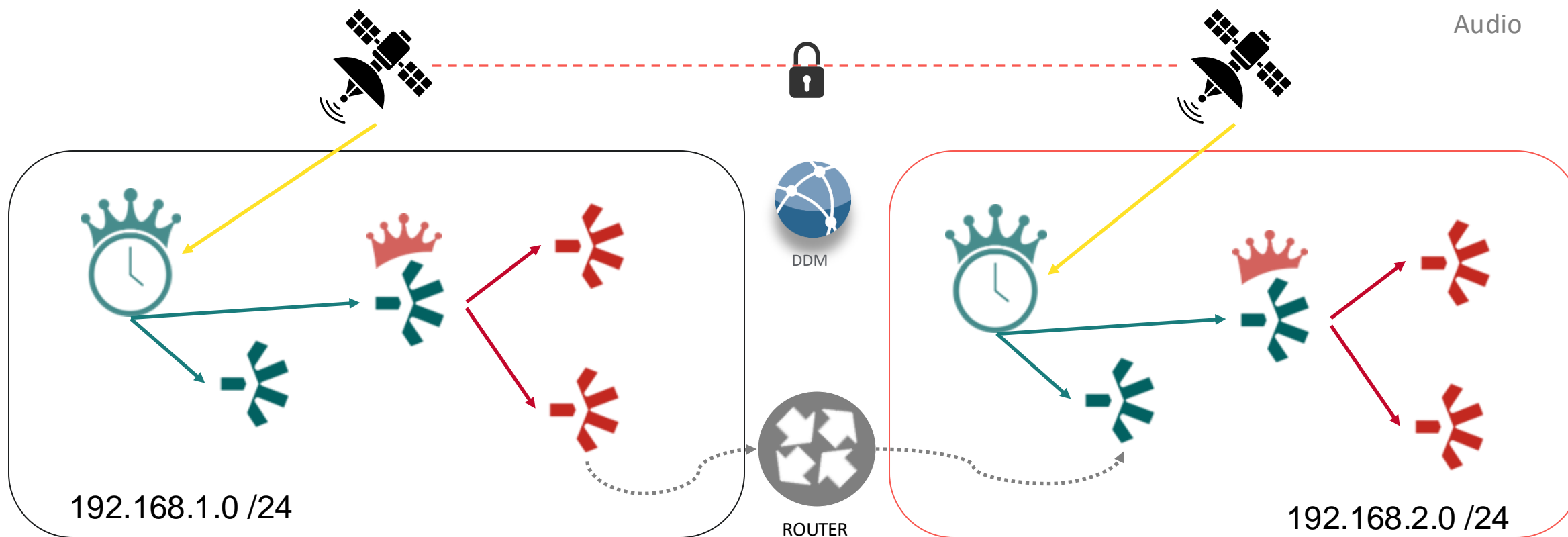

DDM Clock Zoning: PTPv2 aware network

Boundary Clock Network Switches:

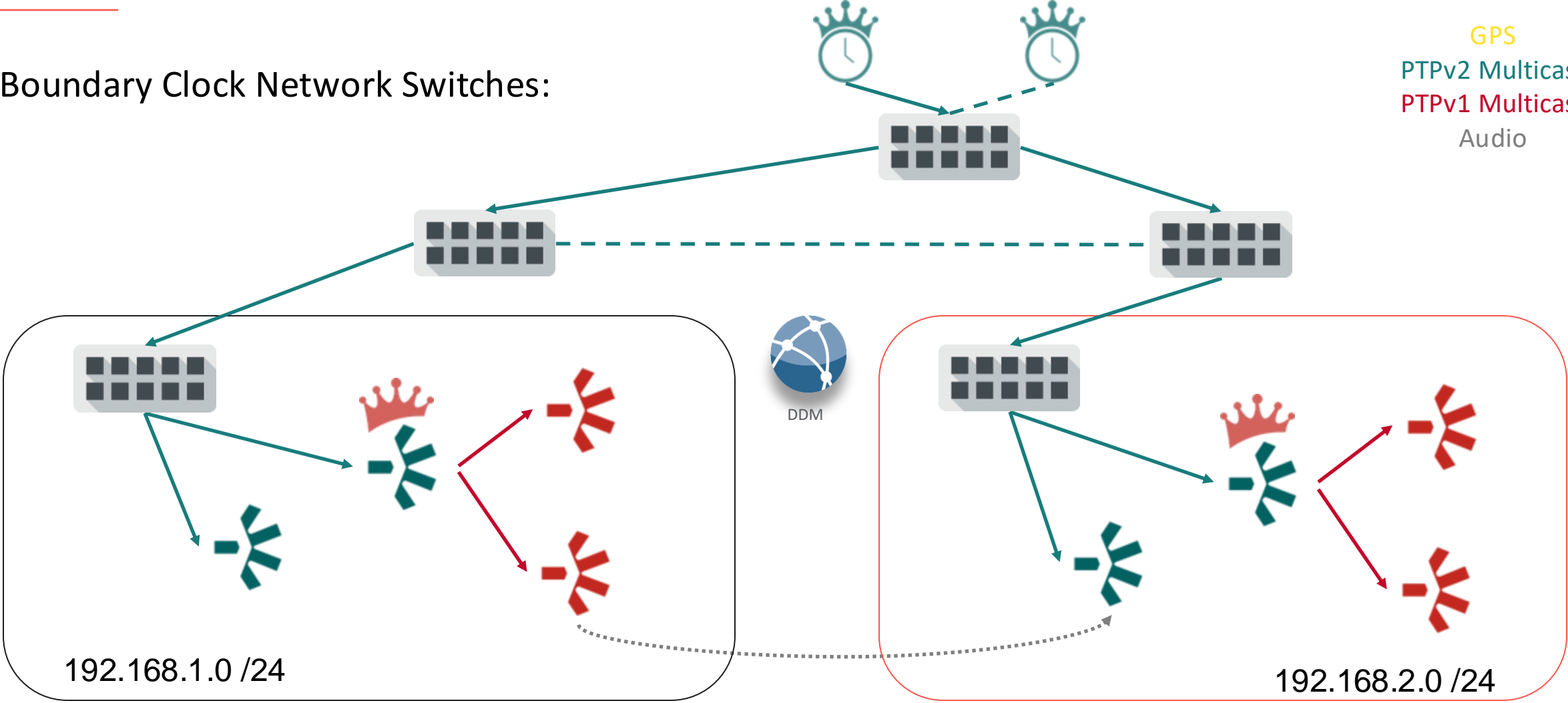

07 Troubleshooting PTP

Clocking not Working?



IGMP Snooping misconfiguration



Energy Efficient Ethernet (EEE) network switches



Asynchronous Networks



Network Jitter



Clock Hierarchy inconsistency



PTPv2 Network misconfiguration

Useful links

<https://www.getdante.com/support/faq/dante-devices-ptp-clocking-support/>

<https://www.getdante.com/support/faq/ptp-ip-addresses-used-by-dante/>

<https://www.getdante.com/support/faq/ptpv2-clocking-options-for-aes67-smpte-interoperability-with-dante/>

<https://www.getdante.com/support/faq/dante-over-distance-considerations/>

<https://www.getdante.com/support/faq/dante-clocking-on-a-cisco-sda-network/>

Special Thanks

Work on this file is a spin off the “PTP Networking Shots” webinar created by Audinate and Cisco (Chris Lapp)



[Webinar: Audinate and Cisco Networking Shorts: PTP - It's About Time](#)

A large crowd of people is seen from behind, looking towards a stage at night. The air is filled with falling confetti. Two small inset images on the left and right show a person sitting on a stage. The word "Questions?" is written in large white letters across the center of the image.

Questions?